



10606

Ford Transit Custom Van Racking



Try **Monster** - Buy **Monster** - Be **Monster**

Specification

Product Description

The Ford Transit Custom Van Rack from Monster Racking is great for storing tools, parts and equipment.

Easy to assemble and hard wearing this plywood van rack comes with 3 shelves, each shelf then has a number of sections that range in size.

Designed to fit inside a Ford Transit Custom Van, this rack can help you get organised and tidy up your van so you can find exactly what you need.

Product Specifics

Dimensions:	136cm High x 102cm Wide x 30cm Deep
Material:	Birch Plywood
Shelves:	3
Top Shelf:	6 Sections
Middle Shelf:	5 Sections
Bottom Shelf:	4 Sections

Monster Guarantee

If you wish to return a product in perfect working order, we provide a 14 day returns policy as long as the item is not assembled and in a resalable condition. A 12 month warranty applies to all of our electrical products, we will cover labour, parts and delivery charges. Our policy is to try and fix the item before arranging an exchange or refund. For full terms and conditions contact our Support department via the details on the 'Contact Us' page.

Specification

Parts List

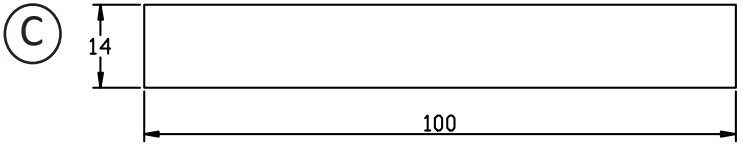
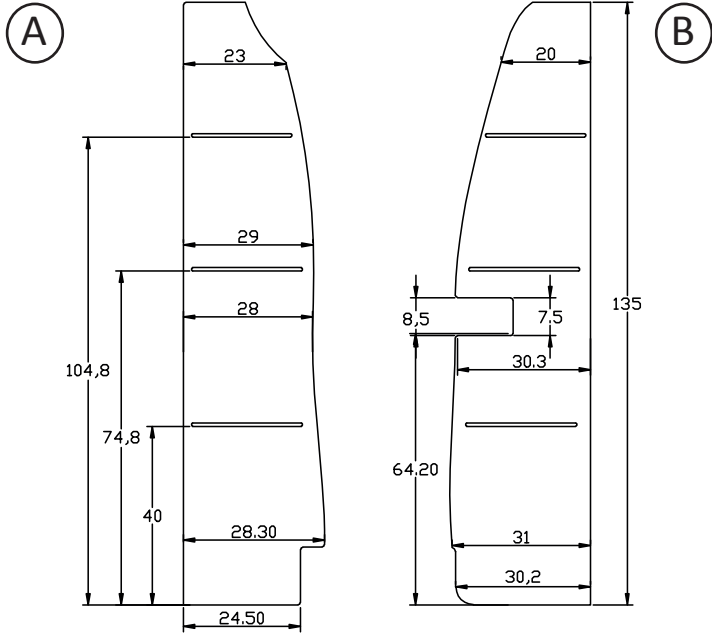

Specifications

Parts List

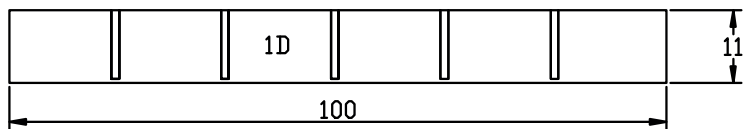
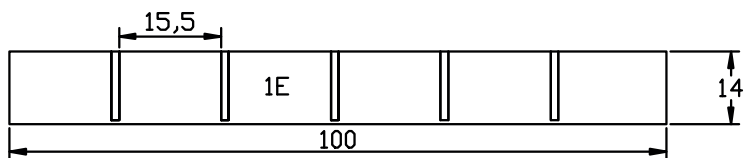
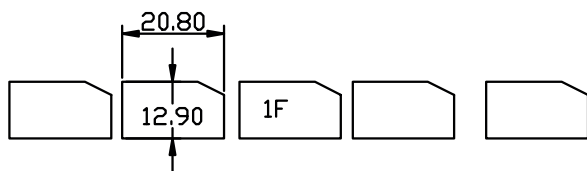

Specification

Parts List

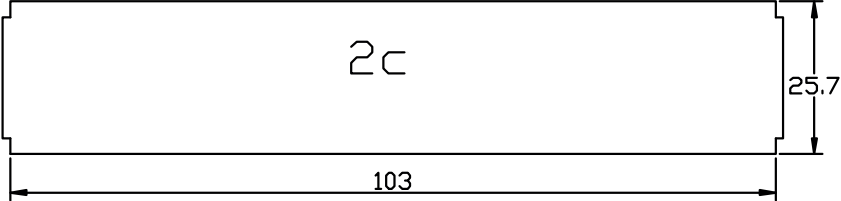
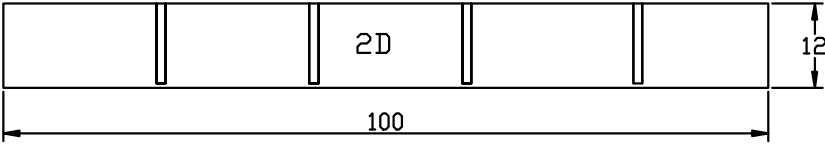
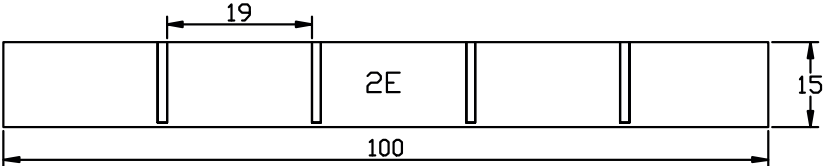
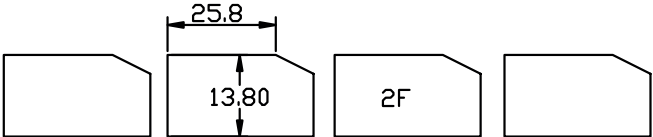

Specifications

Parts List

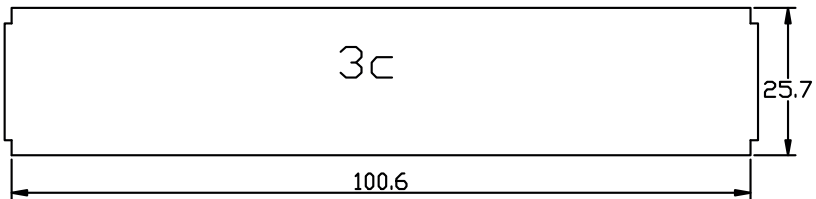
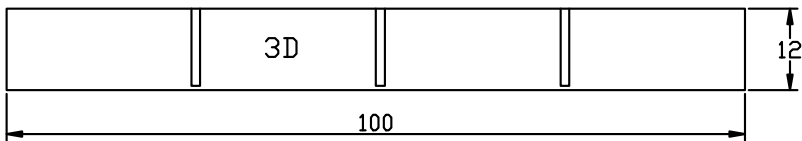
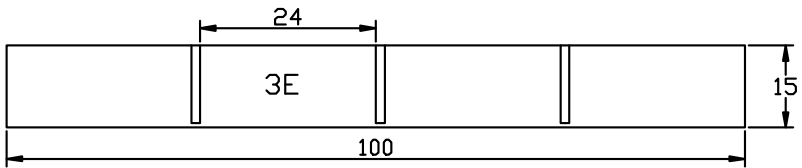
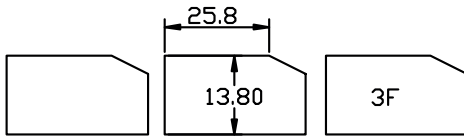

User Guide

Building Instructions

Step 1: Refer to the first page of 'Parts List'.

One of the side panels has a cut out for the door hinge so the two side panels can be turned around depending on where you intend to position the rack.

The long curved edge of each panel will sit against the inside of the van and the long straight edge will face into the van.

Ensure both panels are facing the same way before attaching any shelves.

Then join the two side panels together along the long straight edge, using C and the screws provided, C should sit upright to enclose the bottom of the rack.

User Guide

Building Instructions

Step 2: Refer to the second page of 'Parts List'.

Attach 3C to the side panels, using the screws provided, just above the base seen in Step 1, this forms the base of the bottom shelf.

3E and 3D will form the front and back of the shelf, each has grooves where the shelf dividers (3F) will sit, make sure these grooves are facing inwards.

Attach 3E and 3D to side supports using the screws provided.

You can now slot all the 3F pieces into the bottom shelf.

User Guide

Building Instructions

Step 3: Refer to the third page of 'Parts List'.

Attach 2C to the side panels above the bottom shelf, using the screws provided, this forms the base of the middle shelf.

2E and 2D will form the front and back of the shelf, each has grooves where the shelf dividers (2F) will sit, make sure these grooves are facing inwards.

Attach 2E and 2D to side supports using the screws provided.

You can now slot all the 2F pieces into the middle shelf.

User Guide

Building Instructions

Step 4: Refer to the fourth page of 'Parts List'.

Attach 1C to the side panels above the middle shelf, using the screws provided, this forms the base of the top shelf.

1E and 1D will form the front and back of the shelf, each has grooves where the shelf dividers (1F) will sit, make sure these grooves are facing inwards.

Attach 1E and 1D to side supports using the screws provided.

You can now slot all the 1F pieces into the top shelf.

Now the van rack is complete it can be secured to other plywood panels that line the inside of your van, using the fixing blocks included.

Contact Us

Sales Department

For information regarding this device or other products from our Monster divisions please use the following details below.

Tel: 01347 878888

Email: hello@monstershop.co.uk

Support Department

For queries about this device, warranty, returns or reporting faults please use the following details below.

Tel: 01347 878887

Email: help@monstershop.co.uk

Website

To view our product range and fantastic offers in the Monster divisions please visit our website

www.monstershop.co.uk

Address

To visit our office Monster House and view our products, send postal correspondence or return items our address is provided below.

Monster House, Alan Farnaby Way, Sheriff Hutton
Industrial Estate, Sheriff Hutton, York YO60 6PG



Monster Group (UK) is one of the UK's fastest growing online retailers. We supply a diverse range of products which offer exceptional value for money. We strive to provide the best possible customer experience with free UK delivery across all our products and a Monster Guarantee for 100% satisfaction.

Our dedicated customer service team will be more than happy to help with any questions you may have.

Home & Garden
Storage Shelving
Sign & Digital
Retail & Hospitality
Commercial Equipment

Check out all our Monster brands at www.monstershop.co.uk
