



20244

Drywall Hoist

T-MECH

Try **Monster** - Buy **Monster** - Be **Monster**

Specification

Product Description

The Drywall Hoist brought to you by T-Mech will allow you to raise a sheet of plasterboard without any help. The plasterboard can be lifted to an incredible height over 3 meters to level ceilings, sloped ceilings or even side walls. Additionally, you can lower the plasterboard to 85cm above the ground, carrying a weight of up to 68kg.

Product Specifics

Drywall Panel/Sheet Capacity: 1220 x 4880mm

Maximum Loading Capacity: 150lb/68kg

Minimum Loading Height: 863mm

Maximum Loading Height: 3350mm

Monster Guarantee

If you wish to return a product in perfect working order, we provide a 14 day returns policy as long as the item is unopened and in a resalable condition. A 12 month warranty applies to all of our electrical products, we will cover labour, parts and delivery charges. Our policy is to try and fix the item before arranging an exchange or refund. For full terms and conditions contact our Support department via the details on the Contact page.

Specification

Product Features

- 1) Brake
- 2) Housing
- 3) Black Outrigger
- 4) Cross Arm
- 5) Telescopic Sections
- 6) Cradle
- 7) Handle
- 8) Winch
- 9) Tripod Base
- 10) Wheel

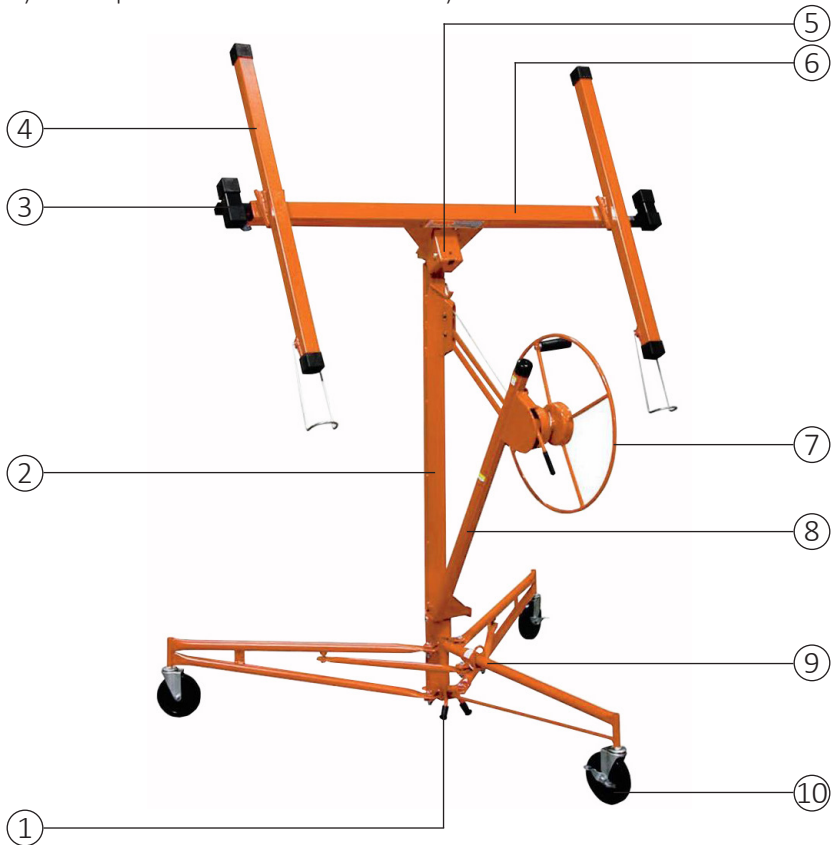

Specification

Parts List

A	Cross Arm	x2
B	Black Outrigger	x2
C	Cradle	x1
D	Main Frame	x1
E	Tripod Base	x1
F	Handle	x1

(A)



(B)



(C)

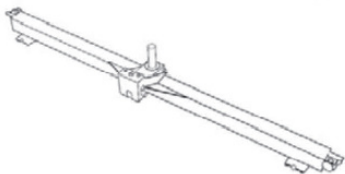

(D)

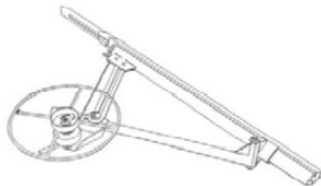

(E)



(F)



User Guide

Assembly Instructions

The Drywall Hoist will need assembling before use. Please follow these simple instructions on how to assemble it.

The Tripod Base:

- 1) Begin with the base. This is a tripod base on castor wheels. Place the base on the floor, with the castor wheels down.
- 2) Press the slide yoke ring whilst simultaneously swinging the two outer legs until the ring snaps into the locking hole that is located on the underside of the slide tube.
- 3) Now in a tripod formation, push the brakes to lock on the castor wheels and set the rubber feet of the backstop down onto the floor. Your base should be formed and sturdy to continue assembly.

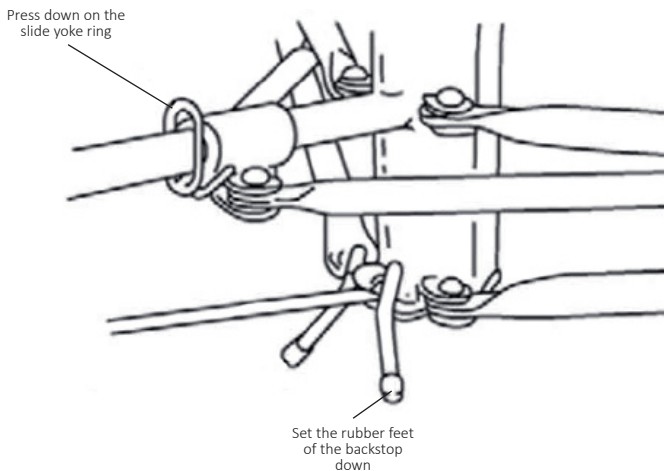

User Guide

Assembly Instructions

The Winch:

1) Slowly slide the bottom end of the main frame into the two V-shaped angled on the tripod base. Slide it all the way down until it is seated securely on the base.

Note: Before continuing any further, check the frame is securely held in place. It should be pushed all the way down and held by the angles.

2) Attach the winch handle and tighten the screw. Then, loosen the screw slightly until the handle can rotate freely.

3) The winch will need moving into working position. To do this, first rotate the handle wheel forward, ensuring the cable has little slack.

4) Secondly, pull the handle wheel away from the main frame. Do this in a controlled manner, with the brake in the released position (held by your left hand) and allow the wheel to turn, releasing the tension in the cable (held in the right hand). Do this until the winch is fully extended and the silver latch sits firmly in place at the bottom. Push it forward slightly so the slide bar locks into place. Release the brake and wheel.

5) Turn the latch clockwise as far as possible to secure it into place.

Note: Check the latch is fully engaged before proceeding.

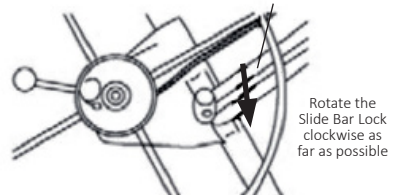
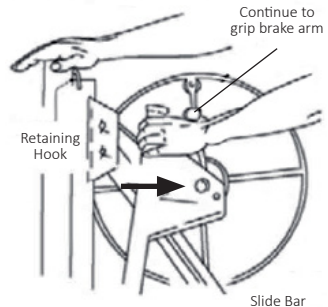
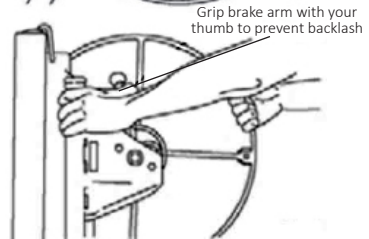
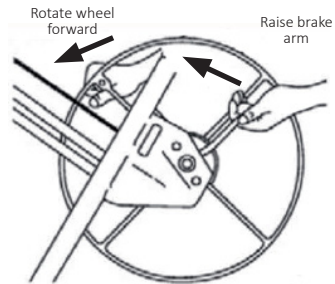

User Guide

Operation Controls

The Cradle Arm:

The Black Outrigger

- 1) First add the black outriggers. To do this, pull out the spring latch located at each end of the cradle.
- 2) Slide one black outrigger into the cradle.
- 3) Fully retract the outrigger, then release the spring latch and make sure it snaps into the corresponding hole.
- 4) Repeat this process with the other outrigger.

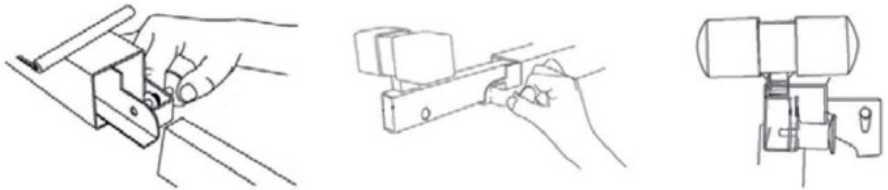

Mounting the Cradle Arm

- 1) Insert the bottom post of the cradle into the opening on the top of the frame.
- 2) Flip the tilt lock up to secure the cradle in place.

Flip the tilt lock
up to secure the
cradle.

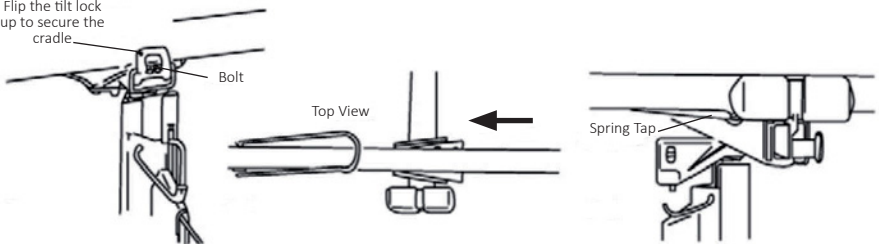

Attaching the Cross Arms

- 1) Slide the plates located on the bottom side of the cross arms into the corresponding holders on the top of the cradle
- 2) Continue the push each cross arm forward into the spring tab on the bottom side of each cross arm snaps into place.

Your Drywall Hoist should now be assembled and ready to use.

User Guide

Operation Controls

Slide Yoke Ring

Press the slide yoke ring down to unlock the two outer legs. By doing this, they can be swung out for further operation or for easy storage of the lifter. The spring-loaded pin snaps into a hole on the base and thus the legs are locked securely.

Backstop

To prevent the tripod base from rolling away during the process of assembly, set the rubber feet of the backstop down on the floor.

Outriggers

The outriggers of the cradle can be used to support a longer sheet of plasterboard. To extend the cradle, pull the spring latch out with your right hand and hold until you can slide out the outrigger with your left hand. Then release the spring latch and guide it into one of the three holes in the outrigger.

Note: Never load the plasterboard to the lifter or adjust the height of the lifter if the spring latches are not engaged or if the outriggers are fully pulled out.

Before transporting or storing the lifter, fully retract the outriggers to avoid damage.

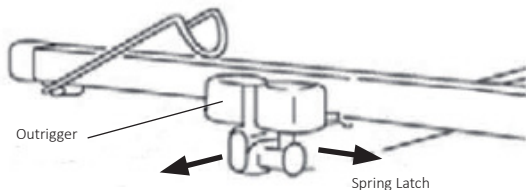
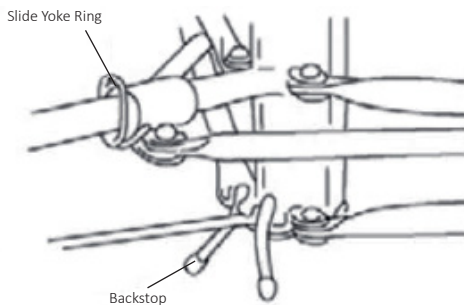

User Guide

Operation Controls

Plasterboard Support Hooks

Spread out the support hooks on each cross arm to support the plasterboard before loading, or after the cradle is tilted. To avoid damage, always swing the support hooks back to the original position before transporting or storing the lifter.

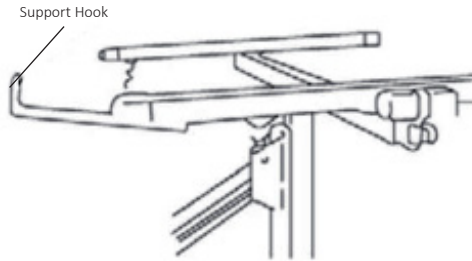

Slide Bar Lock

The slide bar lock holds the fully extended winch at its working position securely. When dismantling the winch for transport or storage, lift the slide bar up and disengage the lock by turning it counter clockwise. This is to the winch can be retracted back to the frame. When preparing the winch for operation, extend the unit by pulling it all the way out towards you and then push the unit back slightly towards the frame. Here, the lock will be engaged automatically. Never tighten the nut on the slide bar lock, otherwise you will be unable to retract the unit for transport or storage.

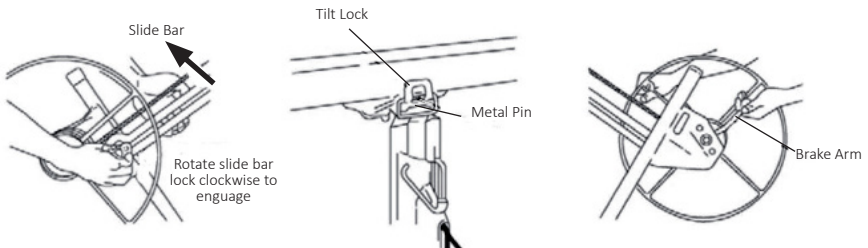

User Guide

Operation Controls

Tilt Lock

To tilt the cradle, or remove it from the frame, pivot the tilt lock out and down. To secure the cradle frame to prevent it from tilting, flip the lock up, engaging the metal pin on the cradle.

Brake Arm

The spring-loaded brake holds the cradle at any height adjusted by cranking the winch wheel. To lower the cradle, first grasp the wheel handle, to restrain backward rotation of the winch before slowly releasing the brake arm.

Wheel, Handle and Winch Post

Cranking the winch (with the handle) can coil or uncoil the cable that raises or lowers the cradle. Grasp the post for leverage which cranking the winch.

Retaining Hook

The retaining hook secures the telescoping section inside the frame for easy transport and storage.

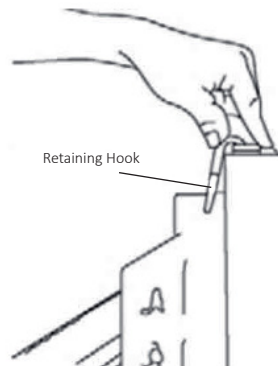
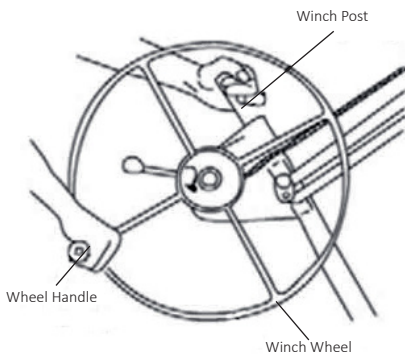

User Guide

Loading the Plasterboard

- 1) Set the rubber feet of the backstop down onto the floor, so that the lifter will not roll away.
- 2) Spread out the plasterboard support hooks of the two cross arms. Turn the cradle properly in such a way that the support hooks are on the opposite side to the winch wheel.
- 3) Pull out the black outriggers of the cradle as needed to fully support the length of the plasterboard.
- 4) Release the tilt lock to tilt the cradle.
- 5) Hold the plasterboard with its paper side against the tilted cradle and load the plasterboard on the support hooks. Carefully lean it against the cross arms.
- 6) When installing the plasterboard to a flat ceiling, tilt the cradle back to its level position and engage the tilt lock. When installing the plasterboard to a side wall or sloped ceiling, leave the cradle tilted.
- 7) The flip the rubber feet of the backstop up to the base and carefully roll the lifter close to the position where the plasterboard is to be installed.

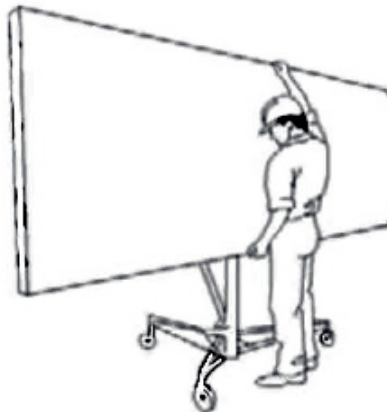

User Guide

Operating Procedure

To Raise the Plasterboard:

Note: Always set the rubber feet of the backstop on the floor before raising the plasterboard.

1) Hold the winch post with one hand and crank the wheel clockwise with the other hand until the plasterboard reaches the desired position.

2) The brake is spring loaded and can hold the drywall securely at the desired height once you stop cranking it up.

To Lower the Plasterboard:

1) Grasp the wheel handle with your right hand so that you can restrain the backward rotation of the winch wheel.

2) Carefully release the brake with your left hand and slowly rotate the wheel backward to lower the cradle.

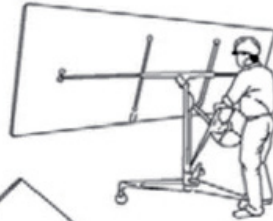
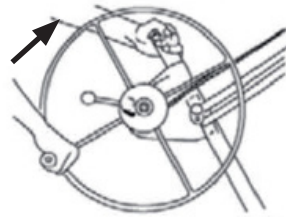

User Guide

Dismantling and Storage

Always store the lifter in a dry, protected area.

Note: To avoid serious injury, be careful of any overhead obstruction when raising the plasterboard. The cradle drops rapidly once the brake arm is released. Before raising the brake, hold the handle with your right hand for better control of the winch.

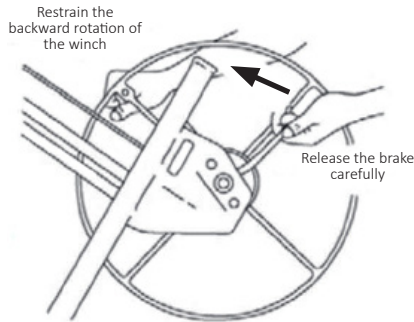

How to Dismantle the Lifter:

- 1) Lower the cradle all the way down by cranking the winch backwards.
- 2) Slide the cradle outriggers in until they are fully retracted. Then swing the support hooks off the cross arms back to the original positions.
- 3) Press the spring tabs on the bottom side and slide the cross arms out from the trapezoidal holders.
- 4) Release the tilt lock. Then lift the cradle up until you can remove it from the frame.

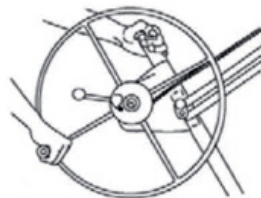
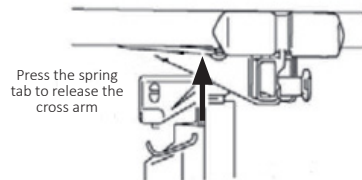

User Guide

Dismantling and Storage

5) Unlock the winch assembly by lifting the slide bar up with your left hand and turning the lock counter clockwise with your right hand.

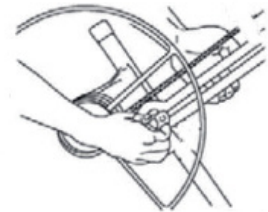

6) Hold the slide bar lock in this disengaged position and crank the winch clockwise with the handle to retract the winch assembly back to the frame.

7) When the slide bar of the winch gets close to the frame housing, take up the slack and tighten the cable by cranking the winch a little further (just enough to hold the winch assembly in this position).

8) Swing up the retraining hook to secure the telescopic sections inside the frame housing of the lifter.

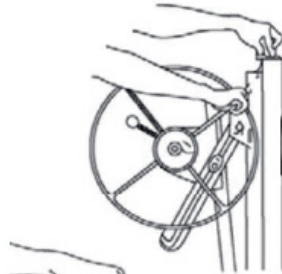

9) Carefully lift the winch assembly up to free it from the tripod base.



10) To fold the base, press the slide yoke ring down and pivot the outer legs back until they are locking into the closed position.

Maintenance

Inspect the cable before each use. Replace it at the first sign of wear. Occasionally lubricate the cable pulleys. Crank up the telescoping sections for access to the internal cable pulley. Never allow the oil or grease to get in contact with the surface of the winch drum.

Occasionally lubricate the bearings.

If the telescoping sections of the frame do not move smoothly, apply household paraffin to the slide surfaces.

Safety Advice

Safe Working Practice

Please read through the safe working practice to ensure prevention of injury or damage to the device.

If damaged, do not use. Pay particular to the condition of the cable.

Ensure the Drywall Hoist is assembled securely before use.

Keep the working area clear from obstructions.

Wear appropriate clothing during use. Always wear a helmet.

Be aware of your surroundings.

Only lift one sheet of plasterboard at a time.

Do not exceed the loading capacities.

Use to lift plasterboard only.

General cleaning and maintenance is required to prolong the working life of the product.



Contact Us

Sales Department

For information regarding this device or other products from our Monster divisions please use the following details below.

Tel: 01347 878888

Email: hello@monstershop.co.uk

Support Department

For queries about this device, warranty, returns or reporting faults please use the following details below.

Tel: 01347 878887

Email: help@monstershop.co.uk

Website

To view our product range and fantastic offers in the Monster divisions please visit our website

www.monstershop.co.uk

Address

To visit our office Monster House and view our products, send postal correspondence or return items our address is provided below.

Monster House, Alan Farnaby Way, Sheriff Hutton
Industrial Estate, Sheriff Hutton, York YO60 6PG



Monster Group (UK) is one of the UK's fastest growing online retailers. We supply a diverse range of products which offer exceptional value for money. We strive to provide the best possible customer experience with free UK delivery across all our products and a Monster Guarantee for 100% satisfaction.

Our dedicated customer service team will be more than happy to help with any questions you may have.

Home & Garden
Storage Shelving
Sign & Digital
Retail & Hospitality
Commercial Equipment

Check out all our Monster brands at www.monstershop.co.uk
