



# KuKoo Work Table

211611 / 211612 / 211613 / 211614 / 211615

INSTRUCTION MANUAL

[www.monstershop.co.uk](http://www.monstershop.co.uk)



# SPECIFICATION

## PRODUCT DESCRIPTION

This KuKoo Work Table will exceed your expectations, not only is it made from strong high quality and durable 201 stainless steel, it come with an adjustable lower shelf. Both the table top and the adjustable lower shelf can hold weights of up to 80kg (176lbs) each.

The KuKoo Work table comes in 5 different sizes to suit many scenarios. The table can be used across a wide range of locations from commercial to home kitchens, garages to utility rooms.

It also comes with the option of 4 castors (2 with brakes) for a manueverable table or 4 strong adjustable feet for stationary use.





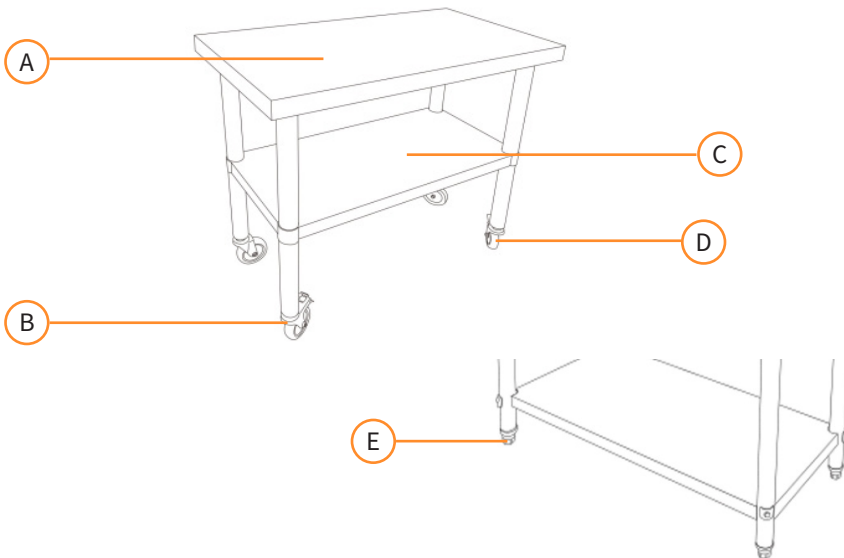



## PRODUCT FEATURES

- A. Stainless Steel Top
- B. 2 x Castors with Brakes
- C. Adjustable Lower Shelf (3 heights)
- D. 2 x Castors
- E. 4 x Adjustable Feet



# SPECIFICATION

## ITEM CONTENTS

Part No		Quantity
A		1
B		1
C		4
D		8
E		4
F		4
G		4
H		2
I		2

Monster Group UK Limited's liability will be limited to the commercial value of the product only.

# SPECIFICATION

## PRODUCT SPECIFICS

	211611	211612	211613	211614	211615
Height (cm)	80	86	86	86	86
Width (cm)	60	60	60	76	76
Depth (cm)	30	45	90	45	90

# SAFETY ADVICE

## SAFE WORKING PRACTICE

- Ensure all parts are properly attached before use.
- Keep the KuKoo Work Table clean to prolong working life.
- DO NOT use corrosive products to clean the Work Table i.e. bleach or cleaners with chlorine or ammonia.
- DO NOT stand or climb on Work Table.
- Distribute weight as evenly as possible.
- DO NOT drop heavy objects on the Work Table.
- Strictly follow weight capacity guidelines below.
- Never exceed 160kg (352lbs) on the Work Table - 80kg (176lbs) per shelf.

# USER GUIDE

## ASSEMBLY INSTRUCTIONS

Insert 'G' into 'C', repeat 3 more times.

Insert 'C' into the under side of 'A', turn 180°, fasten with two screws (D).



Use 'E' and 'F' to fasten the Lower Shelf (B) to the Legs (C).



You are able to choose between the feet or castors.



# TROUBLESHOOTING

## RESOLUTION GUIDE

### WHAT DO I DO IF THERE ARE MISSING PARTS FROM MY ORDER?

If there appears to be any part missing from your order, contact our friendly and helpful Customer Support Team within 7 days of receipt.

**FOR ALL OTHER ISSUES, PLEASE CONTACT OUR  
CUSTOMER SUPPORT TEAM.**

# SPÉCIFICATIONS

## DESCRIPTION DU PRODUIT

Cette table de travail KuKoo dépassera vos attentes, elle est non seulement fabriquée à partir d'un acier inoxydable 201 de haute qualité et durable, mais elle est également équipée d'une étagère inférieure ajustable. La table et l'étagère inférieure peuvent supporter des poids allant jusqu'à 80 kg (176 livres) chacun.

La table de travail KuKoo est disponible en 5 tailles différentes pour convenir à de nombreux scénarios. Elle peut être utilisée dans un large éventail d'emplacements, des cuisines commerciales aux cuisines domestiques, des garages aux buanderies.

Elle est également équipée de 4 roulettes (dont 2 avec freins) pour une table maniable ou de 4 pieds réglables robustes pour une utilisation stationnaire.





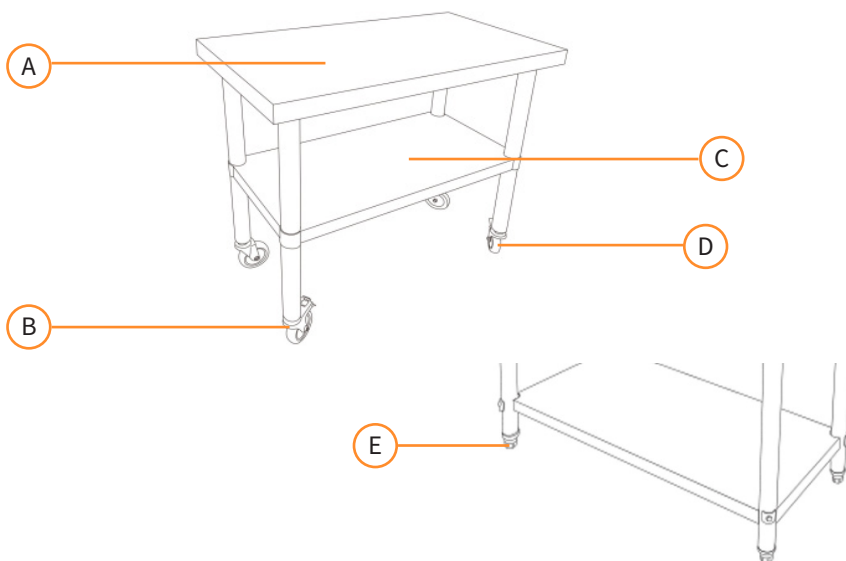



## CARACTÉRISTIQUES DU PRODUIT

- |   |                        |
|---|------------------------|
| A. Plateau en acier inoxydable              | D. 2 x Roulettes       |
| B. 2 x Roulettes avec freins                | E. 4 x Pieds réglables |
| C. Étagère inférieure réglable (3 hauteurs) |                        |



# SPÉCIFICATIONS

## CONTENU DE L'ARTICLE

Référence		Quantité
A		1
B		1
C		4
D		8
E		4
F		4
G		4
H		2
I		2

La responsabilité de Monster Group UK Limited sera limitée à la valeur commerciale du produit.



# SPÉCIFICATIONS

## SPÉCIFICATIONS DU PRODUIT

	211611	211612	211613	211614	211615
Hauteur (cm)	80	86	86	86	86
Largeur (cm)	60	60	60	76	76
Profondeur (cm)	30	45	90	45	90

# CONSEILS DE SÉCURITÉ

## PRATIQUE DE TRAVAIL SÉCURITAIRE

- Assurez-vous que toutes les pièces sont correctement fixées avant utilisation.
- Maintenez la table de travail KuKoo propre pour prolonger sa durée de vie.
- NE PAS utiliser de produits corrosifs pour nettoyer la table de travail, tels que l'eau de Javel ou les nettoyeurs contenant du chlore ou de l'ammoniac.
- NE PAS se tenir ou grimper sur la table de travail.
- Répartissez le poids aussi uniformément que possible.
- NE PAS laisser tomber d'objets lourds sur la table de travail.
- Suivez strictement les directives de capacité de poids ci-dessous.
- Ne jamais dépasser 160 kg (352 lb) sur la table de travail - 80 kg (176 lb) par étagère.

# MODE D'EMPLOI

## INSTRUCTIONS D'ASSEMBLAGE

Insérez 'G' dans 'C', répétez cette opération 3 fois de plus.  
Insérez 'C' dans la partie inférieure de 'A', tournez à 180°, fixez avec deux vis (D).



Utilisez 'E' et 'F' pour fixer l'étagère inférieure (B) aux pieds (C).



Vous pouvez choisir entre les pieds ou les roulettes.



# DÉPANNAGE

## GUIDE DE RÉOLUTION

### QUE FAIRE S'IL MANQUE DES PIÈCES À MA COMMANDE?

S'il semble manquer des pièces à votre commande, contactez notre équipe du service client dans les 7 jours suivant la réception.

**POUR TOUT AUTRE PROBLÈME, VEUILLEZ  
CONTACTER NOTRE ÉQUIPE DU SERVICE CLIENT.**

# SPEZIFIKATIONEN

## PRODUKTBESCHREIBUNG

Dieser KuKoo Arbeitstisch wird Ihre Erwartungen übertreffen. Er ist nicht nur aus robustem, hochwertigem und langlebigem 201 Edelstahl gefertigt, sondern verfügt auch über einen verstellbaren unteren Regalboden. Sowohl die Tischplatte als auch der verstellbare untere Regalboden können jeweils bis zu 80 kg (176 lbs) Gewicht tragen.

Der KuKoo Arbeitstisch ist in 5 verschiedenen Größen erhältlich, um vielen Szenarien gerecht zu werden. Der Tisch kann an vielen Orten eingesetzt werden, von kommerziellen bis hin zu privaten Küchen, Garagen bis hin zu Nutzräumen.

Er kommt auch mit der Option von 4 Rollen (2 mit Bremsen) für einen beweglichen Tisch oder 4 starken verstellbaren Füßen für den stationären Einsatz.





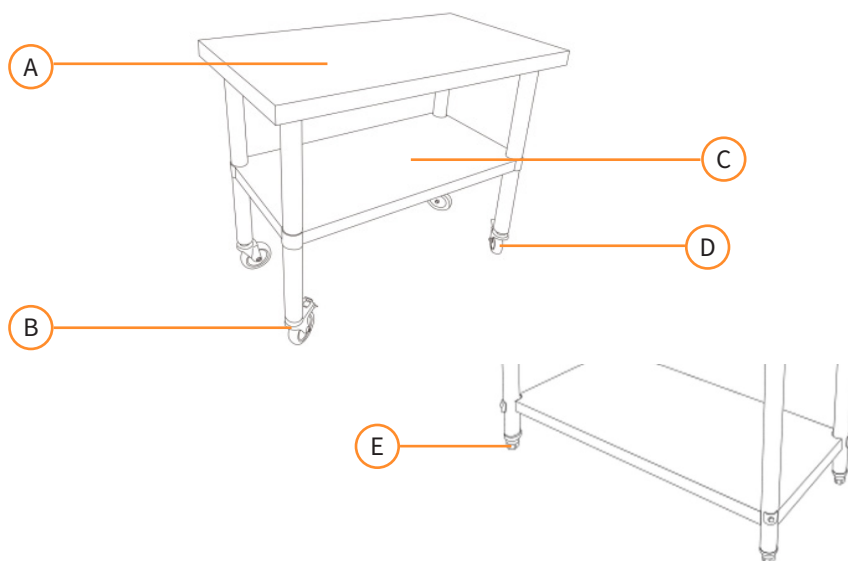



## PRODUKTMERKMALE

- A. Edelstahlplatte
- B. 2 x Rollen mit Bremsen
- C. Verstellbarer unterer Regalboden (3 Höhen)
- D. 2 x Rollen
- E. 4 x verstellbare Füße



# TECHNISCHE DATEN

## LIEFERUMFANG

Teilenummer		Menge
A		1
B		1
C		4
D		8
E		4
F		4
G		4
H		2
I		2

Die Haftung von Monster Group UK Limited ist auf den Handelswert des Produkts beschränkt.

# TECHNISCHE DATEN

## PRODUKTDDETAILS

	211611	211612	211613	211614	211615
Höhe (cm)	80	86	86	86	86
Breite (cm)	60	60	60	76	76
Tiefe (cm)	30	45	90	45	90

# SICHERHEITSHINWEIS

## SICHERES ARBEITEN

- Stellen Sie sicher, dass alle Teile vor der Verwendung ordnungsgemäß befestigt sind.
- Halten Sie den KuKoo Arbeitstisch sauber, um die Lebensdauer zu verlängern.
- VERWENDEN SIE KEINE korrosiven Produkte zur Reinigung des Arbeitstisches, wie z.B. Bleichmittel oder Reinigungsmittel mit Chlor oder Ammoniak.
- STEHEN oder KLETTERN SIE NICHT auf den Arbeitstisch.
- Verteilen Sie das Gewicht so gleichmäßig wie möglich.
- Lassen Sie schwere Gegenstände NICHT auf den Arbeitstisch fallen.
- Befolgen Sie streng die unten angegebenen Gewichtskapazitätsrichtlinien.
- Überschreiten Sie niemals 160kg (352lbs) auf dem Arbeitstisch - 80kg (176lbs) pro Regal.

# BENUTZERLEITFADEN

## MONTAGEANLEITUNGEN

Stecken Sie "G" in "C" und wiederholen Sie dies noch 3 Mal. Stecken Sie "C" auf die Unterseite von "A" und drehen Sie es um 180°. Befestigen Sie es mit zwei Schrauben (D).



Verwenden Sie "E" und "F", um den unteren Regalboden (B) an den Beinen (C) zu befestigen.



Sie können zwischen den Füßen oder Rollen wählen.



# FEHLERBEHEBUNG

## LÖSUNGSGUIDE

### WAS MACHE ICH, WENN BEI MEINER BESTELLUNG TEILE FEHLEN?

Falls bei Ihrer Bestellung ein Teil zu fehlen scheint, wenden Sie sich bitte innerhalb von 7 Tagen nach Erhalt der Ware an unser freundliches und hilfsbereites Kundenservice-Team.

**FÜR ALLE ANDEREN FRAGEN WENDEN SIE SICH BITTE AN  
UNSER KUNDENSERVICE-TEAM.**





# ESPECIFICACIÓN

## DESCRIPCIÓN DEL PRODUCTO

Esta Mesa de Trabajo KuKoo superará tus expectativas, no solo está hecha de acero inoxidable 201 fuerte, de alta calidad y duradero, sino que también cuenta con un estante inferior ajustable. Tanto la parte superior de la mesa como el estante inferior ajustable pueden soportar pesos de hasta 80 kg (176 libras) cada uno.

La Mesa de Trabajo KuKoo viene en 5 tamaños diferentes para adaptarse a muchas situaciones. La mesa se puede utilizar en una amplia gama de lugares, desde cocinas comerciales hasta hogareñas, garajes hasta salas de utilidad.

También viene con la opción de 4 ruedas giratorias (2 con frenos) para una mesa maniobrable o 4 patas fuertes y ajustables para uso estacionario.





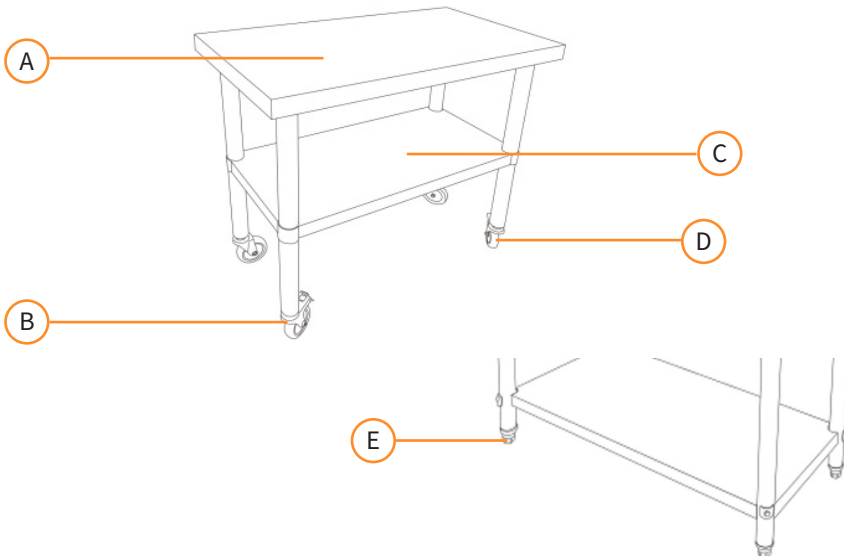



## CARACTERÍSTICAS DEL PRODUCTO

- |   |                         |
|---|-------------------------|
| A. Encimera de acero inoxidable           | D. 2 x ruedecillas      |
| B. 2 x ruedecillas con frenos             | E. 4 x patas ajustables |
| C. Estante inferior ajustable (3 alturas) |                         |



# ESPECIFICACIÓN

## CONTENIDOS DEL ARTÍCULO

Número de pieza		Cantidad
A		1
B		1
C		4
D		8
E		4
F		4
G		4
H		2
I		2

La responsabilidad de Monster Group UK Limited estará limitada únicamente al valor comercial del producto.

# ESPECIFICACIÓN

## ESPECIFICACIONES DEL PRODUCTO

	211611	211612	211613	211614	211615
Altura (cm)	80	86	86	86	86
Ancho (cm)	60	60	60	76	76
Profundidad (cm)	30	45	90	45	90

## CONSEJOS DE SEGURIDAD

### PRÁCTICAS DE TRABAJO SEGURAS

- Asegúrese de que todas las piezas estén correctamente fijadas antes de usar.
- Mantenga la Mesa de Trabajo KuKoo limpia para prolongar su vida útil.
- NO use productos corrosivos para limpiar la Mesa de Trabajo, como lejía o limpiadores con cloro o amoníaco.
- NO se ponga de pie ni suba a la Mesa de Trabajo.
- Distribuya el peso lo más uniformemente posible.
- NO deje caer objetos pesados sobre la Mesa de Trabajo.
- Siga estrictamente las pautas de capacidad de peso a continuación.
- Nunca exceda los 160 kg (352 libras) en la Mesa de Trabajo - 80 kg (176 libras) por estante.

# GUÍA DEL USUARIO

## INSTRUCCIONES DE ENSAMBLAJE

Inserte "G" en "C", repita 3 veces más.  
Inserte "C" en la parte inferior de "A",  
gírelo 180° y fíjelo con dos tornillos  
(D).



Use "E" y "F" para fijar el Estante  
Inferior (B) a las Patas (C).



Puede elegir entre las patas o las ruedas giratorias.



# SOLUCIÓN DE PROBLEMAS

## GUÍA DE RESOLUCIÓN

### ¿QUÉ PUEDO HACER SI LE FALTAN PIEZAS A MI PEDIDO?

Si parece faltar alguna pieza en su pedido, por favor, comuníquese con nuestro amable y servicial Equipo de Atención al Cliente en los 7 días posteriores a la recepción de su pedido.

**PARA CUALQUIER OTRO PROBLEMA, POR FAVOR CONTACTE  
CON NUESTRO EQUIPO DE ATENCIÓN AL CLIENTE**

# SPECIFICHE

## DESCRIZIONE DEL PRODOTTO

Questo Tavolo da Lavoro KuKoo supererà le tue aspettative, non solo perché è realizzato in acciaio inossidabile 201 resistente, di alta qualità e duraturo, ma anche perché è dotato di un ripiano inferiore regolabile. Sia il piano del tavolo che il ripiano inferiore regolabile possono sostenere pesi fino a 80 kg ciascuno (176 libbre).

Il tavolo da lavoro KuKoo è disponibile in 5 diverse dimensioni per adattarsi a molteplici scenari. Può essere utilizzato in una vasta gamma di ambienti, dalle cucine commerciali a quelle domestiche, dai garage alle lavanderie.

Inoltre, è disponibile l'opzione di 4 ruote (2 con freni) per un tavolo manovrabile o 4 robusti piedini regolabili per un uso stazionario.





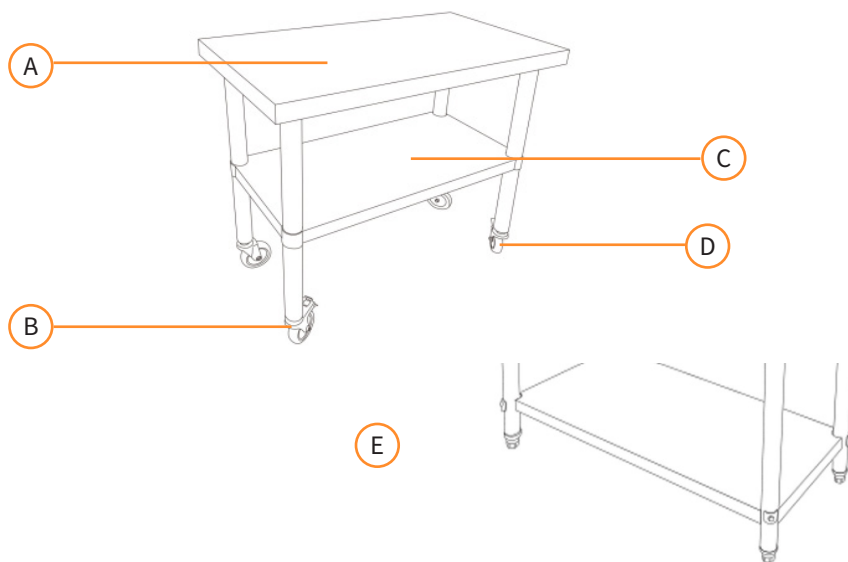



## CARATTERISTICHE DEL PRODOTTO

- A. Piano in acciaio inossidabile
- B. 2 x Ruote con freni
- C. Ripiano inferiore regolabile (3 altezze)
- D. 2 x Ruote
- E. 4 x Piedini regolabili



# SPECIFICHE

## CARATTERISTICHE DEL PRODOTTO

Numero di parte		Quantità
A		1
B		1
C		4
D		8
E		4
F		4
G		4
H		2
I		2

La responsabilità di Monster Group UK Limited sarà limitata al solo valore commerciale del prodotto.

# SPECIFICHE

## CARATTERISTICHE DEL PRODOTTO

	211611	211612	211613	211614	211615
Altezza (cm)	80	86	86	86	86
larghezza (cm)	60	60	60	76	76
Profondità (cm)	30	45	90	45	90

# CONSIGLI PER LA SICUREZZA

## PRATICHE DI LAVORO SICURO

- Assicurarsi che tutte le parti siano correttamente fissate prima dell'uso.
- Mantenere pulito il tavolo da lavoro KuKoo per prolungarne la durata.
- NON utilizzare prodotti corrosivi per pulire il tavolo da lavoro, ad esempio candeggina o detersivi contenenti cloro o ammoniaca.
- Non stare in piedi o salire sul tavolo da lavoro.
- Distribuire il peso il più uniformemente possibile.
- Non far cadere oggetti pesanti sul tavolo da lavoro.
- Attenersi strettamente alle linee guida della capacità di peso indicate di seguito.
- Non superare mai i 160 kg (352 libbre) sul tavolo da lavoro - 80 kg (176 libbre) per ripiano.



# GUIDA UTENTE

## ISTRUZIONI PER IL MONTAGGIO

Inserire "G" in "C", ripetere altre 3 volte.  
Inserire "C" nella parte inferiore di "A",  
ruotare di 180°, fissare con due viti (D).



Utilizzare "E" e "F" per fissare il  
ripiano inferiore (B) alle gambe (C).



È possibile scegliere tra i piedini o le rotelle.



# RISOLUZIONE DEI PROBLEMI

## GUIDA ALLA RISOLUZIONE DEI PROBLEMI

### COSA DEVO FARE SE NEL MIO ORDINE CI SONO DELLE PARTI MANCANTI?

Se sembra che all'interno del tuo ordine manchino delle parti, contatta il nostro gentile e disponibile team di assistenza clienti entro 7 giorni dalla ricezione del tuo ordine.

**PER QUALUNQUE ALTRO PROBLEMA, CONTATTA IL NOSTRO TEAM DI ASSISTENZA CLIENTI.**

# OMSCHRIJVING

## PRODUCT OMSCHRIJVING

Deze KuKoo Werktafel overtreft uw verwachtingen. Hij is niet alleen gemaakt van sterk, hoogwaardig en duurzaam 201 roestvrij staal, maar wordt ook geleverd met een in hoogte verstelbare onderste plank. Zowel het tafelblad als de verstelbare onderste plank kunnen elk tot 80 kg (176 lbs) dragen.

De KuKoo Werktafel is verkrijgbaar in 5 verschillende maten om aan verschillende behoeften te voldoen. De tafel kan worden gebruikt op een breed scala aan locaties, van commerciële keukens tot thuiskeukens, garages tot utility rooms.

Het wordt geleverd met de optie van 4 zwenkwielen (2 met remmen) voor een gemakkelijk manoeuvreerbare tafel of 4 sterke verstelbare poten voor stationair gebruik.





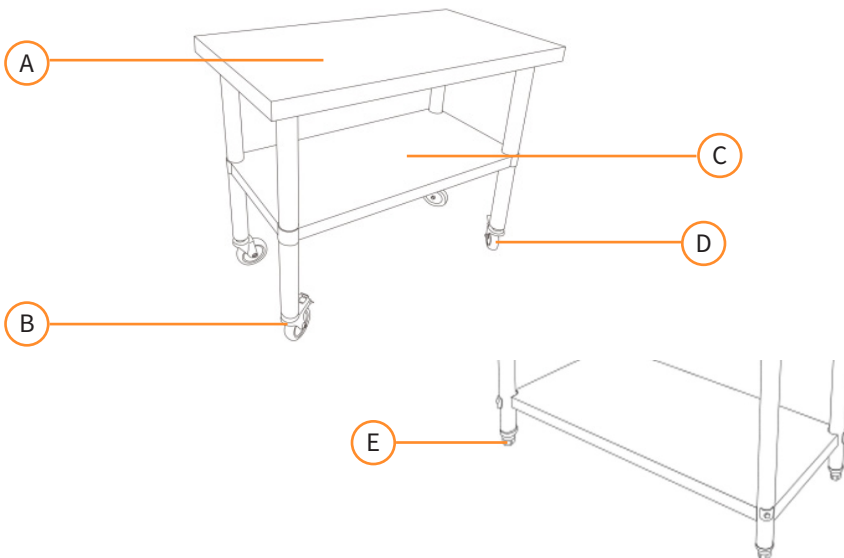



## PRODUCTKENMERKEN

- |   |                          |
|---|--------------------------|
| A. Roestvrijstalen blad                   | D. 2 x zwenkwielen       |
| B. 2 x zwenkwielen met remmen             | E. 4 x verstelbare poten |
| C. Verstelbare onderste plank (3 hoogtes) |                          |



# SPECIFICATIE

## ITEM INHOUD

Onderdeelnummer		Hoeveelheid
A		1
B		1
C		4
D		8
E		4
F		4
G		4
H		2
I		2

De aansprakelijkheid van Monster Group UK Limited is beperkt tot de commerciële waarde van het product.

# SPECIFICATIE

## PRODUCTSPECIFIEK

	211611	211612	211613	211614	211615
Hoogte (cm)	80	86	86	86	86
Breedte (cm)	60	60	60	76	76
Diepte (cm)	30	45	90	45	90

# VEILIGHEIDSADVIJES

## VEILIG GEBRUIK

- Zorg ervoor dat alle onderdelen goed zijn bevestigd voordat u de tafel gebruikt.
- Houd de KuKoo Werktafel schoon om de levensduur te verlengen.
- GEBRUIK GEEN corrosieve producten om de Werktafel schoon te maken, zoals bleekmiddel of reinigingsmiddelen met chloor of ammoniak.
- STA NIET op de Werktafel of klim erop.
- Verdeel het gewicht zo gelijkmatig mogelijk.
- GOOI GEEN zware voorwerpen op de Werktafel.
- Volg strikt de gewichtscapaciteit richtlijnen hieronder.
- Overschrijd nooit 160 kg (352 lbs) op de Werktafel - 80 kg (176 lbs) per plank.

# GEBRUIKERSHANDLEIDING

## MONTERINGSINSTRUCTIES

Steek 'G' in 'C', herhaal nog 3 keer.  
Steek 'C' in de onderkant van 'A';  
draai 180° en bevestig met twee  
schroeven (D).



Gebruik 'E' en 'F' om de Onderste  
Plank (B) aan de Poten (C) te  
bevestigen.



U kunt kiezen tussen de poten of zwenkwielen.



# PROBLEEM OPLOSSEN

## OPLOSSINGEN

### WAT MOET IK DOEN ALS ER ONDERDELEN VAN MIJN BESTELLING ONTBREKEN?

Neem wanneer een onderdeel van je bestelling ontbreekt binnen 7 dagen na ontvangst contact op met onze vriendelijke en behulpzame klantenservice.

**NEEM VOOR ALLE ANDERE KWESTIES CONTACT  
MET ONZE KLANTENSERVICE OP.**



# SPECIFIKATION

## PRODUKTBeskrivning

Denna Arbetsbänk från KuKoo kommer att överträffa dina förväntningar. Enheten är inte bara tillverkad av starkt och hållbart 201-klassat rostfritt stål av hög kvalitet, det har även en justerbar undre hylla. Både bordsskivan och den justerbara undre hyllan kan bära vikter på upp till 80 kg (176 pund) vardera.

Arbetsbänken finns i 5 olika storlekar för att passa många olika användningsområden. Bänken kan användas i mängd olika miljöer, från kommersiella kök till hemmakök, garage till förrådsutrymmen.

Det finns också alternativet att välja 4 hjul (2 med bromsar) för ett rörligt bord eller 4 starka justerbara fötter för stationärt bruk.

## PRODUKTFUNKTIONER

A. Rostfri toppskiva

B. 2 x Hjul med broms

C. Justerbar undre hylla (3 höjder)

D. 2 x Hjul



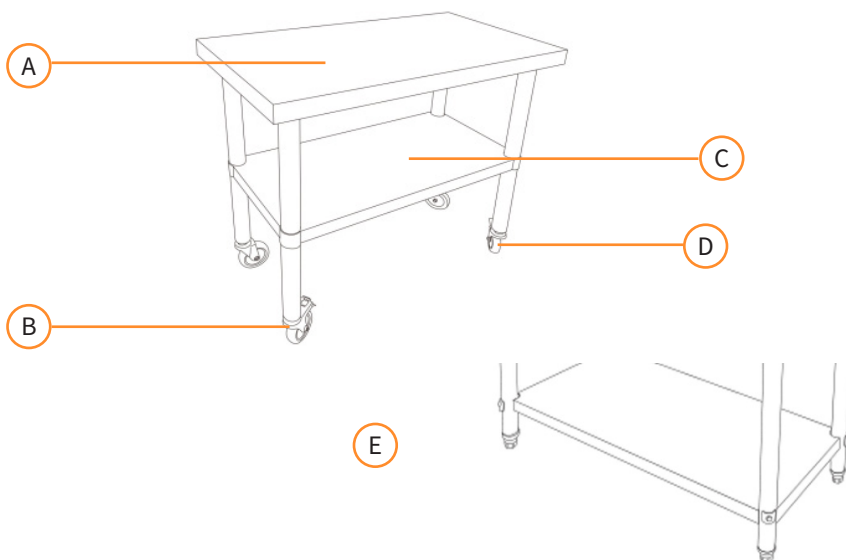





E. 4 x Justerbara fötter





# SPECIFIKATION

## ARTIKELINNEHÅLL

Artikelnummer		Antal
A		1
B		1
C		4
D		8
E		4
F		4
G		4
H		2
I		2

Monster Group UK Limiteds ansvar begränsas endast till produktens kommersiella värde.

# SPECIFIKATION

## PRODUKTSPECIFIKATIONER

	211611	211612	211613	211614	211615
Höjd (cm)	80	86	86	86	86
Bredd (cm)	60	60	60	76	76
Djup (cm)	30	45	90	45	90

# SÄKERHETSÅD

## SÅKER ARBETSÖVNING

- Se till att alla delar är ordentligt monterade innan användning.
- Håll arbetsbänken ren för att förlänga dess livslängd.
- ANVÅND INTE korrosiva produkter för att rengöra arbetsbänken, t.ex. blekmedel eller rengöringsmedel med klor eller ammoniak.
- STÅ ELLER KLÅTTRA INTE på arbetsbänken.
- Fördela vikten så jämnt som möjligt.
- SLÅPP INTE tunga föremål på arbetsbänken.
- Följ strikt riktlinjerna för viktkapacitet nedan.
- Överskrid aldrig 160 kg (352 pund) på arbetsbänken - 80 kg (176 pund) per hylla.

# ANVÄNDARGUIDE

## MONTERINGS INSTRUKTIONER

Placera in "G" i "C", upprepa 3 gånger till. Placera "C" på undersidan av "A", vrid 180°, fäst med två skruvar (D).



Använd "E" och "F" för att fästa den undre hyllan (B) på benen (C).



Du kan välja mellan fötter eller hjul.



# FELSÖKNING

## LÖSNINGSGUIDE

### VAD GÖR JAG OM DET SAKNAS DELAR FRÅN MIN BESTÄLLNING?

Om det verkar som om någon del saknas i din beställning, kontakta vårt vänliga och hjälpsamma kundsupportteam inom 7 dagar efter mottagandet.

**FÖR ALLA ANDRA FRÅGOR, VÄNLIGEN KONTAKTA VÅRT  
KUNDSUPPORTTEAM.**



Monster Group (UK) is one of the UK's fastest growing online retailers. We supply a diverse range of products which offer exceptional value for money. We strive to provide the best possible customer experience with free UK delivery across all our products and a Monster Guarantee for 100% satisfaction.

For information regarding this device or other products from our Monster divisions please contact Sales.

### SALES

TEL: 01347 878 888  
EMAIL: hello@monstershop.co.uk

For queries about this device, warranty, returns or reporting faults please contact Support.

### SUPPORT

TEL: 01347 878 887  
EMAIL: help@monstershop.co.uk

Pour plus d'informations concernant cet appareil ou d'autres produits de nos divisions de Monster veuillez utiliser les détails suivants ci-dessous.

### DÉPARTEMENT COMMERCIAL

TEL: 01347 878 888  
EMAIL: bonjour@monstershop.eu

Pour les interrogations concernant cet appareil, la garantie, les retours ou les défauts de déclaration veuillez utiliser les détails suivants ci-dessous.

### DÉPARTEMENT DE SOUTIEN

TEL: 01347 878 887  
EMAIL: help@monstershop.co.uk

Para información sobre este dispositivo u otros productos de nuestras divisiones de Monster por favor use los siguientes detalles.

### DEPARTAMENTO DE VENTAS

TEL: 01347 878 888  
EMAIL: hola@monstershop.eu

Para consultas sobre este dispositivo, la garantía, devoluciones o denuncias de fallos por favor use los siguientes detalles.

### DEPARTAMENTO DE SOPORTE

TEL: 01347 878 887  
EMAIL: help@monstershop.co.uk

Für Informationen bezüglich dieses Geräts oder anderer Produkte aus unserer Monster-Abteilung, benutzen sie die folgenden unten aufgeführten Angaben.

### VERKAUFSABTEILUNG

TEL: 01347 878 888  
EMAIL: hallo@monstershop.eu

Für Fragen über dieses Gerät, die Garantie, Rückgaben oder bei Störungen, benutzen sie die folgenden unten aufgeführten Angaben.

### SUPPORT-ABTEILUNG

TEL: 01347 878 887  
EMAIL: help@monstershop.co.uk

Per informazioni riguardanti questo dispositivo o altri prodotti dalle categorie Monster utilizzare i dettagli sotto riportati.

### DIPARTIMENTO VENDITE

TEL: 01347 878 888  
EMAIL: ciao@monstershop.eu

Per domande riguardo dispositivo, garanzia, reso o per riferire di guasti, utilizzare i dettagli sotto riportati.

### DIPARTIMENTO SUPPORTO

TEL: 01347 878 887  
EMAIL: help@monstershop.co.uk

Voor informatie over dit apparaat of andere producten van onze Monster-divisies kunt u contact opnemen met onze verkoop afdeling. Significantes details.

### VERKOOP

TEL: 01347 878 888  
EMAIL: hello@monstershop.co.uk

Voor vragen over dit apparaat, garantie, retourzendingen of het melden van fouten kunt u contact opnemen met de klanten support. Significantes details.

### SUPPORT

TEL: 01347 878 887  
EMAIL: help@monstershop.co.uk

Monster House, Alan Farnaby Way,  
Sheriff Hutton Industrial Estate,  
Sheriff Hutton, York, YO60 6PG

[www.monstershop.co.uk](http://www.monstershop.co.uk)



För information om denna enhet eller andra produkter från våra Monster-divisioner vänligen kontakta vårt hjälpsamma säljteam. Significantes details.

### SALES

TEL: 01347 878 888  
EMAIL: hello@monstershop.co.uk

Kontakta vår kundsupport för frågor om denna enhet, garanti, retur eller felrapportering.

### SUPPORT

TEL: 01347 878 887  
EMAIL: help@monstershop.co.uk

 Try **Monster. Buy Monster. Be Monster.** 