



6ft x 10ft GREEN GREENHOUSE (with & without a base)

26538/26546

INSTRUCTION MANUAL

www.monstershop.co.uk



SPECIFICATION

PRODUCT DESCRIPTION

The Monster Greenhouse is a flat pack, easy to assemble, aluminium/polycarbonate garden greenhouse. It is 6ft wide & 10ft long.

PRODUCT SPECIFICS

4mm Polycarbonate glazing
0.8mm – 1.3mm Aluminium frame
0.8mm steel base (optional)
Width - 6' 0"
Length - 10' 0"

TOOLS & SAFETY EQUIPMENT REQUIRED

1. Gloves
2. Step ladder
3. Powered screw driver with a Philips No 1 head
4. 10mm spanner or socket
5. Set square

Note: These tools are not provided. At least two people are needed to assemble this greenhouse.

Monster Group UK Limited's liability will be limited to the commercial value of the product only.

SPECIFICATION

PRODUCT FEATURES



































- A. Galvanised aluminium frame
- B. Twin wall polycarbonate glazing
- C. Hollow box profile aluminium ridge beam for greater strength and rigidity
- D. Clipped glazing system allows for easy changing of poly carbonate panels
- E. Diagonal braces in the side walls provide greater structural rigidity
- F. Opening roof vent
- G. Sliding door
- H. Galvanized steel base (optional)
- I. Apex roof & Gutters



SPECIFICATION

























PARTS LIST

When first unpacking your greenhouse, check each part against this list to ensure that they are all present. Each part is clearly labelled. If any are missing contact us before attempting to assemble.

#		MM	#x	#		MM	#x
1		1214 mm	4x	17		1830 mm	1x
2		1132 mm	1x	18			4x
3		1132 mm	1x	19		380 mm	1x
4		1132 mm	1x	20		1586 mm	2x
5		1132 mm	1x	21		1830 mm	1x
6		1639 mm	1x	22		1302 mm	4x
7		1639 mm	1x	23		595 mm	2x
8		1665 mm	1x	24		616 mm	1x
9		1665 mm	1x	25		1292 mm	2x
10		1214 mm	8x	26		616 mm	2x
11		1115 mm	8x	27		616 mm	1x
12		618 mm	1x	28		M6x10	158x
13			4x	29		M6 mm	159x
14		1255 mm	1x	30		522 mm	4x
15		635 mm	2x	31		609 mm	1x
16		1830 mm	1x	32		595 mm	2x











SPECIFICATION

PARTS LIST

#		MM	#x	#		MM	#x
33		598 mm	2x	49		400 mm	2x
34		1555 mm	2x	50			1x
35		1525 mm	2x	51			2x
36		1532.5 mm	2x	52		M6x30 mm	1x
37		1640 mm	4x	53			3x
38		1555 mm	2x	54			2x
39		1532.5 mm	2x	55			1x
40			166x				
41		605 mm	5x				
42			8x				
43			4x				
44			1x				
45			1x				
46			2x				
47		M4.5 x19 mm	16x				
48		M4x7.5	12x				

SPECIFICATION

PARTS LIST

#		MM	#x
1		605x1210 mm	15x
2		605x1130 mm	8x
3		605x450 mm	2x
4		605x590 mm	2x
5		600x549 mm	2x
6		605x 662 mm	1x
7		610x224 mm	1x
8		615x232 mm	1x
9		610x602 mm	2x
10		605x450 mm	2x

SAFETY ADVICE

SAFE WORKING PRACTICE

Please read through the Safe Working Practice to ensure prevention of injury or damage to the greenhouse.

Ensure you have read and fully understood the instruction manual and safety advice before assembling this product.

At least two people are required to assemble this greenhouse.

Ensure that this greenhouse is handled and assembled according to these instructions.

Do not attempt to assemble this greenhouse on a windy day.

Ensure this greenhouse is assembled and erected on a flat surface.

Ensure this product is assembled securely.

Ensure this product is erected in a safe place.

This product must be anchored to the ground.

Do not use this product for anything other than its intended purposes.

Ensure that all other materials used with this product are up to standard.

TROUBLESHOOTING

RESOLUTION GUIDE

WHAT DO I DO IF THERE ARE MISSING PARTS FROM MY ORDER?

If there appears to be any part missing from your order, contact our friendly and helpful Customer Support Team within 7 days of receipt.

**FOR ALL OTHER ISSUES, PLEASE CONTACT OUR
CUSTOMER SUPPORT TEAM.**



ESPECIFICACIONES

DESCRIPCIÓN DEL PRODUCTO

El Invernadero de Monster viene en un paquete plano que contiene un invernadero de jardín de aluminio/policarbonato de fácil montaje. Mide 1,80 de ancho y 3,05 de alto.

ESPECIFICACIONES DEL PRODUCTO

4mm de acristalamiento de policarbonato

0.8mm - 1.3mm Marco de aluminio

Base de acero de 0,8 mm (opcional)

Ancho - 6' 0"

Largo - 10' 0"

REQUISITOS DE HERRAMIENTAS Y SEGURIDA

1. Guantes
2. Escalera
3. Destornillador eléctrico con una punta Philips N°1
4. Llave de tuerca o de vaso de 10mm
5. Escuadra

Nota: Estas herramientas no están incluidas. Se necesitarán al menos dos personas para montar este invernadero.

La responsabilidad de Monster Group UK se limitará al valor comercial del producto.

ESPECIFICACIONES

CARACTERÍSTICAS DEL PRODUCTO











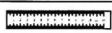























- A. Estructura de aluminio galvanizado
- B. Acristalamiento de policarbonato para las paredes gemelas
- C. Viga de cumbrera de perfiles de aluminio para más solidez y rigidez mayor rigidez estructural
- D. El sistema de cristal con clip permite cambiar fácilmente los paneles de policarbonato
- E. Los tirantes diagonales en las paredes laterales proporcionan una mayor rigidez estructural
- F. Abertura de ventilación en el techo
- G. Puerta corredera
- H. Base de acero galvanizado (opcional)
- I. Techo con vértice y canalón



ESPECIFICACIONES

























CONTENIDO DEL ARTÍCULO

Cuando desempaque el invernadero, compruebe si todas las piezas están presentes. Cada pieza está claramente etiquetada. Si faltase alguna, póngase en contacto con nosotros antes de intentar montarlo.

#		 MM	#x	#		 MM	#x
1		1214 mm	4x	17		1830 mm	1x
2		1132 mm	1x	18			4x
3		1132 mm	1x	19		380 mm	1x
4		1132 mm	1x	20		1586 mm	2x
5		1132 mm	1x	21		1830 mm	1x
6		1639 mm	1x	22		1302 mm	4x
7		1639 mm	1x	23		595 mm	2x
8		1665 mm	1x	24		616 mm	1x
9		1665 mm	1x	25		1292 mm	2x
10		1214 mm	8x	26		616 mm	2x
11		1115 mm	8x	27		616 mm	1x
12		618 mm	1x	28		M6x10	158x
13			4x	29		M6 mm	159x
14		1255 mm	1x	30		522 mm	4x
15		635 mm	2x	31		609 mm	1x
16		1830 mm	1x	32		595 mm	2x











ESPECIFICACIONES

CONTENIDO DEL ARTÍCULO

#		MM	#x	#		MM	#x
33		598 mm	2x	49		400 mm	2x
34		1555 mm	2x	50			1x
35		1525 mm	2x	51			2x
36		1532.5 mm	2x	52		M6x30 mm	1x
37		1640 mm	4x	53			3x
38		1555 mm	2x	54			2x
39		1532.5 mm	2x	55			1x
40			166x				
41		605 mm	5x				
42			8x				
43			4x				
44			1x				
45			1x				
46			2x				
47		M4.5 x19 mm	16x				
48		M4x7.5	12x				

ESPECIFICACIONES

CONTENIDO DEL ARTÍCULO

#		MM	#x
1		605x1210 mm	15x
2		605x1130 mm	8x
3		605x450 mm	2x
4		605x590 mm	2x
5		600x549 mm	2x
6		605x 662 mm	1x
7		610x224 mm	1x
8		615x232 mm	1x
9		610x602 mm	2x
10		605x450 mm	2x

CONSEJO DE SEGURIDAD

PRÁCTICA SEGURA DE MANEJO

Lea atentamente la Práctica Segura de Manejo para garantizar la prevención de lesiones y daños al invernadero.

Asegúrese de haber leído y comprendido el manual de instrucciones antes de montar este producto.

Se requieren al menos dos personas para montar este invernadero.

Asegúrese de que el invernadero se manipula y se monta conforme a estas instrucciones. No intente montar este invernadero en un día de viento.

Asegúrese de que este invernadero se monta y se construye sobre una superficie plana. Asegúrese de montar este producto de una forma segura.

Asegúrese de que este producto se construye en un lugar seguro. Este producto debe ser anclado al suelo.

No use este producto para ninguna otra cosa que para el propósito para el que se ha diseñado. Asegúrese de que los materiales utilizados con este producto sean de buena calidad.

RESOLUCIÓN DE PROBLEMAS

GUÍA DE RESOLUCIÓN

¿QUÉ HAGO SI FALTAN PIEZAS EN MI PEDIDO?

Si parece que faltasen piezas de su pedido, póngase en contacto con nuestro amable y servicial Equipo de Atención al Cliente durante los 7 días tras la entrega del producto.

PARA CUALQUIER OTRA CUESTIÓN, NO DUDE EN PONERSE EN CONTACTO CON NUESTRO EQUIPO DE ATENCIÓN AL CLIENTE.



SPEZIFIKATIONEN

PRODUKTBESCHREIBUNG

Das Monster-Gewächshaus ist ein flaches, leicht zu montierendes Gartengewächshaus aus Aluminium/Polycarbonat. Es ist 6 Fuß (1,82m) breit und 10 Fuß (3,05m) lang.

PRODUKTSPEZIFIKATIONEN

4 mm Polycarbonat-Verglasung
0,8 mm - 1,3 mm Aluminium-Rahmen
0,8-mm-Stahlsockel (optional)
Breite - 183cm
Länge - 305cm

BENÖTIGTE WERKZEUGE & SICHERHEITSAUSSTATTUNG

1. Schutzhandschuhe
2. Trittleiter
3. Angetriebener Schraubendreher mit einem Philips Nr. 1 Schraubenkopf.
4. 10mm Schraubschlüssel oder Steckdose
5. Vierkant setzen

Hinweis: Diese Werkzeuge werden nicht zur Verfügung gestellt. Für die Aufstellung dieses Gewächshauses werden mindestens zwei Personen benötigt.

Die Haftung der Monster Group UK Limited ist ausschließlich auf den Handelswert des Produkts beschränkt.

SPEZIFIKATIONEN

PRODUKTEIGENSCHAFTEN





























- A. Rahmen aus verzinktem Aluminium
- B. Doppelwandige Verglasung aus Polycarbonat
- C. Aluminium-Hohlkastenprofil als Firstbalken für mehr Festigkeit und Starrheit.
- D. Das Verglasungs-System ermöglicht den einfachen Austausch von Polycarbonat-Platten
- E. Diagonalstreben in den Seitenwänden sorgen für eine höhere strukturelle Standfähigkeit
- F. Dachluke zum Öffnen
- G. Schiebetür
- H. Sockel aus verzinktem Stahl (optional)
- I. Scheiteldach & Rinnen



SPEZIFIKATIONEN

























INHALTSLISTE

Wenn Sie Ihr Gewächshaus zum ersten Mal auspacken, vergewissern Sie sich, dass alle Teile aus dieser Liste vorhanden sind. Jedes Teil ist deutlich gekennzeichnet. Sollten welche fehlen, kontaktieren Sie uns, bevor Sie versuchen, das Gewächshaus aufzubauen.

#		MM	#x	#		MM	#x
1		1214 mm	4x	17		1830 mm	1x
2		1132 mm	1x	18			4x
3		1132 mm	1x	19		380 mm	1x
4		1132 mm	1x	20		1586 mm	2x
5		1132 mm	1x	21		1830 mm	1x
6		1639 mm	1x	22		1302 mm	4x
7		1639 mm	1x	23		595 mm	2x
8		1665 mm	1x	24		616 mm	1x
9		1665 mm	1x	25		1292 mm	2x
10		1214 mm	8x	26		616 mm	2x
11		1115 mm	8x	27		616 mm	1x
12		618 mm	1x	28		M6x10	158x
13			4x	29		M6 mm	159x
14		1255 mm	1x	30		522 mm	4x
15		635 mm	2x	31		609 mm	1x
16		1830 mm	1x	32		595 mm	2x











SPEZIFIKATIONEN

INHALTSLISTE

#		MM	#x	#		MM	#x
33		598 mm	2x	49		400 mm	2x
34		1555 mm	2x	50			1x
35		1525 mm	2x	51			2x
36		1532.5 mm	2x	52		M6x30 mm	1x
37		1640 mm	4x	53			3x
38		1555 mm	2x	54			2x
39		1532.5 mm	2x	55			1x
40			166x				
41		605 mm	5x				
42			8x				
43			4x				
44			1x				
45			1x				
46			2x				
47		M4.5 x19 mm	16x				
48		M4x7.5	12x				

SPEZIFIKATIONEN

INHALTSLISTE

#		MM	#x
1		605x1210 mm	15x
2		605x1130 mm	8x
3		605x450 mm	2x
4		605x590 mm	2x
5		600x549 mm	2x
6		605x 662 mm	1x
7		610x224 mm	1x
8		615x232 mm	1x
9		610x602 mm	2x
10		605x450 mm	2x

SICHERHEITSHINWEISE

SICHERES ARBEITEN

Bitte lesen Sie den Abschnitt "Sicheres Arbeiten" durch, um Verletzungen oder Schäden am Gewächshaus zu vermeiden.

Vergewissern Sie sich, dass Sie die Bedienungsanleitung und die Sicherheitshinweise gelesen und vollständig verstanden haben, bevor Sie dieses Produkt montieren.

Für den Zusammenbau dieses Gewächshauses sind mindestens zwei Personen erforderlich.

Stellen Sie sicher, dass dieses Gewächshaus gemäß dieser Anleitung gehandhabt und aufgebaut wird. Versuchen Sie nicht, dieses Gewächshaus an einem besonders windigen Tag zu montieren.

Vergewissern Sie sich, dass das Gewächshaus auf einer ebenen Fläche montiert und aufgestellt wird. Vergewissern Sie sich, dass dieses Produkt sicher montiert ist.

Stellen Sie sicher, dass dieses Produkt an einem sicheren Ort aufgestellt wird. Das Produkt muss am Boden verankert werden.

Verwenden Sie dieses Produkt nur für den vorgesehenen Zweck. Vergewissern Sie sich, dass alle anderen mit diesem Produkt verwendeten Materialien dem Standard entsprechen.

FEHLERBEHEBUNG

LÖSUNGSGUIDE

WAS MACHE ICH, WENN IN MEINER BESTELLUNG TEILE FEHLEN?

Wenn ein Teil Ihrer Lieferung zu fehlen scheint, kontaktieren Sie bitte unser freundliches und hilfsbereites Kundenserviceteam innerhalb von 7 Tagen nach Erhalt.

**FÜR ALLE ANDEREN FRAGEN KÖNNEN SIE SICH AN UNSER
KUNDEN-SUPPORTTEAM WENDEN.**

SPECIFICHE

DESCRIZIONE DEL PRODOTTO

La Monster Greenhouse è una serra da giardino semplice, facile da montare, in alluminio/policarbonato. È larga 6 piedi & lunga 10 piedi.

SPECIFICHE DEL PRODOTTO

Pannelli in Policarbonato da 4mm
Telaio in Alluminio da 0.8mm - 1.3mm
Base in Acciaio da 0.8mm (opzionale)
Larghezza - 183cm
Lunghezza - 305cm

ATTREZZATURE DI SICUREZZA RICHIESTE

1. Guanti
2. Scala a pioli
3. Cacciavite elettrico con punta Philips n.1
4. Chiave da 10 mm
5. Squadretta

Nota: Questi strumenti non sono forniti. Per assemblare questa serra sono necessarie almeno due persone.

La responsabilità di Monster Group UK Limited sarà limitata al valore commerciale del prodotto.

SPECIFICHE

CARATTERISTICHE DEL PRODOTTO































- A. Telaio in alluminio zincato
- B. Doppia parete in vetro policarbonato
- C. Trave profilata a trave profilata in alluminio per una maggiore resistenza e rigidità
- D. Pannelli con sistema ad incastro per cambiare il policarbonato con facilità
- E. Barre oblique nelle pareti laterali forniscono una maggiore rigidità strutturale
- F. Tetto apribile per lo sfiato
- G. Porta scorrevole
- H. Base in acciaio zincato (opzionale)
- I. Tetto apribile & grondaie



SPECIFICHE

























CONTENUTO

Quando si disimballa per la prima volta la serra, controllare ogni parte in questo elenco per assicurarsi che siano tutte presenti. Ogni parte è chiaramente etichettata. Se ne manca qualcuna, contattaci prima di tentare il montaggio.

#		MM	#x	#		MM	#x
1		1214 mm	4x	17		1830 mm	1x
2		1132 mm	1x	18			4x
3		1132 mm	1x	19		380 mm	1x
4		1132 mm	1x	20		1586 mm	2x
5		1132 mm	1x	21		1830 mm	1x
6		1639 mm	1x	22		1302 mm	4x
7		1639 mm	1x	23		595 mm	2x
8		1665 mm	1x	24		616 mm	1x
9		1665 mm	1x	25		1292 mm	2x
10		1214 mm	8x	26		616 mm	2x
11		1115 mm	8x	27		616 mm	1x
12		618 mm	1x	28		M6x10	158x
13			4x	29		M6 mm	159x
14		1255 mm	1x	30		522 mm	4x
15		635 mm	2x	31		609 mm	1x
16		1830 mm	1x	32		595 mm	2x











SPECIFICHE

CONTENUTO

#		MM	#x	#		MM	#x
33		598 mm	2x	49		400 mm	2x
34		1555 mm	2x	50			1x
35		1525 mm	2x	51			2x
36		1532.5 mm	2x	52		M6x30 mm	1x
37		1640 mm	4x	53			3x
38		1555 mm	2x	54			2x
39		1532.5 mm	2x	55			1x
40			166x				
41		605 mm	5x				
42			8x				
43			4x				
44			1x				
45			1x				
46			2x				
47		M4.5 x19 mm	16x				
48		M4x7.5	12x				

SPECIFICHE

CONTENUTO

#		MM	#x
1		605x1210 mm	15x
2		605x1130 mm	8x
3		605x450 mm	2x
4		605x590 mm	2x
5		600x549 mm	2x
6		605x 662 mm	1x
7		610x224 mm	1x
8		615x232 mm	1x
9		610x602 mm	2x
10		605x450 mm	2x

AVVISO DI SICUREZZA

PRATICHE DI LAVORO SICURE

Leggere le Pratiche di lavoro sicure per prevenire lesioni o danni alla serra.

Assicurarsi di aver letto e compreso a fondo il manuale di istruzioni e i consigli di sicurezza prima di assemblare questo prodotto.

Per assemblare questa serra sono necessarie almeno due persone.

Accertarsi che questa serra sia gestita e assemblata secondo queste istruzioni.

Non tentare di montare questa serra durante una giornata ventosa.

Assicurarsi che questa serra sia montata ed eretta su una superficie piana. Assicurarsi che questo prodotto sia assemblato in modo sicuro.

Assicurarsi che questo prodotto sia installato in un luogo sicuro. Questo prodotto deve essere ancorato al suolo.

Non utilizzare questo prodotto per scopi diversi da quelli previsti. Assicurarsi che tutti gli altri materiali utilizzati con questo prodotto siano conformi allo standard.

RISOLUZIONE DEI PROBLEMI

GUIDA ALLA RISOLUZIONE

COSA FACCIO SE NEL MIO ORDINE CI SONO PARTI MANCANTI?

Se nel tuo ordine sembra che manchi qualche componente, contatta il nostro amichevole Team di Assistenza Clienti e entro 7 giorni dal recapito.

PER TUTTI GLI ALTRI PROBLEMI, CONTATTA NOSTRO TEAM DI ASSISTENZA CLIENTI.

SPÉCIFICATION

DESCRIPTION DU PRODUIT

La serre Monster Greenhouse est une serre de jardin en aluminium/polycarbonate à monter, facile à assembler et plate. Elle mesure 6 pieds de large et 10 pieds de long.

CARACTÉRISTIQUES DU PRODUIT

Vitrage en polycarbonate de 4 mm
Cadre en aluminium de 0,8 mm - 1,3 mm
Base en acier de 0,8 mm (facultatif)
Largeur - 183cm
Longueur - 305cm

OUTILS ET EQUIPEMENTS DE SECURITÉ REQUIS

1. Gants
2. Escabeau
3. Tournevis motorisé à tête plate Philips
4. Clé ou douille de 10mm
5. Grande équerre

Remarque: Ces outils ne sont pas fournis. Au moins deux personnes sont nécessaires pour assembler cette serre.

La responsabilité de Monster Group UK Limited se limite à la valeur commerciale du produit uniquement.

SPÉCIFICATION

CARACTÉRISTIQUES DU PRODUIT

































- A. Cadre en aluminium galvanisé
- B. Vitrage en polycarbonate à double paroi
- C. Poutre faîtière en aluminium à profil creux pour plus de solidité et de rigidité
- D. Le système de vitrage clipsé permet de changer facilement les panneaux de polycarbonate
- E. Des renforts diagonaux dans les parois latérales assurent une plus grande rigidité structurelle
- F. Ouverture d'aération par le toit
- G. Porte coulissante
- H. Base en acier galvanisé (optionel)
- I. Toit et gouttières Ape



SPÉCIFICATION

























LISTE DES PIÈCES

Lorsque vous déballez votre serre pour la première fois, vérifiez chaque pièce par rapport à cette liste pour vous assurer qu'elles sont toutes présentes. Chaque pièce est clairement étiquetée. S'il en manque, contactez-nous avant d'essayer de les assembler.

#		MM	#x	#		MM	#x
1		1214 mm	4x	17		1830 mm	1x
2		1132 mm	1x	18			4x
3		1132 mm	1x	19		380 mm	1x
4		1132 mm	1x	20		1586 mm	2x
5		1132 mm	1x	21		1830 mm	1x
6		1639 mm	1x	22		1302 mm	4x
7		1639 mm	1x	23		595 mm	2x
8		1665 mm	1x	24		616 mm	1x
9		1665 mm	1x	25		1292 mm	2x
10		1214 mm	8x	26		616 mm	2x
11		1115 mm	8x	27		616 mm	1x
12		618 mm	1x	28		M6x10	158x
13			4x	29		M6 mm	159x
14		1255 mm	1x	30		522 mm	4x
15		635 mm	2x	31		609 mm	1x
16		1830 mm	1x	32		595 mm	2x











SPÉCIFICATION

LISTE DES PIÈCES

#		MM	#x	#		MM	#x
33		598 mm	2x	49		400 mm	2x
34		1555 mm	2x	50			1x
35		1525 mm	2x	51			2x
36		1532.5 mm	2x	52		M6x30 mm	1x
37		1640 mm	4x	53			3x
38		1555 mm	2x	54			2x
39		1532.5 mm	2x	55			1x
40			166x				
41		605 mm	5x				
42			8x				
43			4x				
44			1x				
45			1x				
46			2x				
47		M4.5 x19 mm	16x				
48		M4x7.5	12x				

SPÉCIFICATION

LISTE DES PIÈCES

#		MM	#x
1		605x1210 mm	15x
2		605x1130 mm	8x
3		605x450 mm	2x
4		605x590 mm	2x
5		600x549 mm	2x
6		605x 662 mm	1x
7		610x224 mm	1x
8		615x232 mm	1x
9		610x602 mm	2x
10		605x450 mm	2x

AVIS DE SÉCURITÉ

CONSIGNES DE SÉCURITÉ A RESPECTER

Veillez lire attentivement les consignes de sécurité afin de vous protéger contre les blessures et les dommages qui pourraient être causés par la construction de la serre.

Assurez-vous d'avoir lu et bien compris le mode d'emploi et les consignes de sécurité avant d'assembler ce produit.

Au moins deux personnes sont requises pour assembler cette serre.

Assurez-vous que cette serre soit manipulée et assemblée conformément à ces instructions. N'essayez pas d'assembler cette serre par temps venteux.

Assurez-vous que cette serre soit assemblée et érigée sur une surface plate. Assurez-vous que ce produit soit bien assemblé.

Assurez-vous que ce produit est installé dans un endroit sûr. Ce produit doit être ancré au sol.

N'utilisez pas ce produit à d'autres fins que celles auxquelles il est destiné. Assurez-vous que tous les autres matériaux utilisés avec ce produit sont conformes aux normes.

DÉPANNAGE

GUIDE DE RÉOLUTION

QUE DOIS-JE FAIRE S'IL MANQUE DES PIÈCES DANS MA COMMANDE ?

S'il semble y avoir une pièce manquante dans votre commande, contactez notre service clientèle dans les 7 jours suivant sa réception.

POUR TOUT AUTRE PROBLÈME, VEUILLEZ CONTACTER NOTRE SERVICE CLIENTÈLE.



SPECIFICATIE

PRODUCTBESCHRIJVING

De Monster Tuinkas is een platte, eenvoudig te monteren tuinkas van aluminium/polycarbonaat. Het is 6 voet breed en 10 voet lang.

PRODUCTEIGENSCHAPPEN

4mm Polycarbonaatglas
0.8mm - 1.3mm Aluminium frame
0,8 mm stalen basis (optioneel)
Breedte - 183 cm
Lengte - 305 cm

BENODIGDE GEREEDSCHAP & VEILIGHEIDSUITRUSTING

1. Handschoenen
2. Ladder
3. Accu schroefmachine met een Philips 3mm kop.
4. 10mm Engelse sleutel of dopsleutel
5. Gradenboog

Let op! Deze gereedschappen worden niet meegeleverd. Er zijn minimaal twee mensen nodig om deze kas te monteren

De aansprakelijkheid van Monster Group UK Limited is beperkt tot de commerciële waarde van het product.

SPECIFICATIE

PRODUCTKENMERKEN





























- A. Gegalvaniseerd aluminium frame
- B. Dubbelwandige polycarbonaat beglazing
- C. Aluminium nokbalk met holle profielen voor grotere sterkte en stijfheid
- D. Het beglazingssysteem met clips maakt het mogelijk om eenvoudig polycarbonaat panelen te verwisselen
- E. Diagonale beugels in de zijwanden zorgen voor een goede structurele stevigheid
- F. Ventilatie dakraam
- G. Schuifdeur
- H. Gegalvaniseerde stalen basis (optioneel)
- I. Zadeldak & Goten



SPECIFICATIE

























INHOUD ONDERDELEN

Controleer bij het eerste keer uitpakken van uw kas elk onderdeel van deze lijst om er zeker van te zijn dat alles aanwezig is. Elk onderdeel is duidelijk geëtiketteerd. Als er iets ontbreekt, neem dan contact met ons op voordat u probeert te monteren.

#		MM	#x	#		MM	#x
1		1214 mm	4x	17		1830 mm	1x
2		1132 mm	1x	18			4x
3		1132 mm	1x	19		380 mm	1x
4		1132 mm	1x	20		1586 mm	2x
5		1132 mm	1x	21		1830 mm	1x
6		1639 mm	1x	22		1302 mm	4x
7		1639 mm	1x	23		595 mm	2x
8		1665 mm	1x	24		616 mm	1x
9		1665 mm	1x	25		1292 mm	2x
10		1214 mm	8x	26		616 mm	2x
11		1115 mm	8x	27		616 mm	1x
12		618 mm	1x	28		M6x10	158x
13			4x	29		M6 mm	159x
14		1255 mm	1x	30		522 mm	4x
15		635 mm	2x	31		609 mm	1x
16		1830 mm	1x	32		595 mm	2x











SPECIFICATIE

INHOUD ONDERDELEN

#		MM	#x	#		MM	#x
33		598 mm	2x	49		400 mm	2x
34		1555 mm	2x	50			1x
35		1525 mm	2x	51			2x
36		1532.5 mm	2x	52		M6x30 mm	1x
37		1640 mm	4x	53			3x
38		1555 mm	2x	54			2x
39		1532.5 mm	2x	55			1x
40			166x				
41		605 mm	5x				
42			8x				
43			4x				
44			1x				
45			1x				
46			2x				
47		M4.5 x19 mm	16x				
48		M4x7.5	12x				

SPECIFICATIE

INHOUD ONDERDELEN

#		MM	#x
1		605x1210 mm	15x
2		605x1130 mm	8x
3		605x450 mm	2x
4		605x590 mm	2x
5		600x549 mm	2x
6		605x 662 mm	1x
7		610x224 mm	1x
8		615x232 mm	1x
9		610x602 mm	2x
10		605x450 mm	2x

VEILIGHEIDSADVIES

VEILIGHEIDSVOORSCHRIFTEN

Lees A.U.B de veiligheidsvoorschriften door om letsel of schade aan de kas te voorkomen.

Zorg ervoor dat u de handleiding en de veiligheidsvoorschriften hebt gelezen en volledig begrijpt voordat u dit product monteert.

Er zijn minimaal twee mensen nodig om deze kas te monteren.

Zorg ervoor dat deze kas volgens deze instructies gemonteerd wordt.

Probeer deze kas niet op een winderige dag te monteren.

Zorg ervoor dat deze kas op een vlakke ondergrond is gemonteerd en geplaatst.

Zorg ervoor dat dit product stevig is gemonteerd.

Zorg ervoor dat dit product op een veilige plek wordt geplaatst. Dit product moet aan de grond worden verankerd.

Gebruik dit product niet voor een ander reden dan waarvoor het bedoeld is. Zorg ervoor dat alle andere materialen die met dit product worden gebruikt, voldoen aan de standaard.

PROBLEEMOPLOSSING

RESOLUTIEGIDS

WAT DOE IK ALS ER ONDERDELEN VAN MIJN BESTELLING ONTBREEKT?

Als er een onderdeel ontbreekt in uw bestelling, neem dan binnen 7 dagen na ontvangst, contact op met ons vriendelijke en behulpzame klantenserviceteam.

NEEM VOOR ALLE ANDERE AANGELEGENHEDEN CONTACT OP MET ONZE KLANTENSERVICE.

USER GUIDE

ASSEMBLY INSTRUCTIONS

 INSTRUCTIONS DE MONTAGE

 MONTAGEANLEITUNG

 INSTRUCCIONES DE MONTAJE

 ISTRUZIONI DI MONTAGGIO

 MONTAGEHANDLEIDING

1

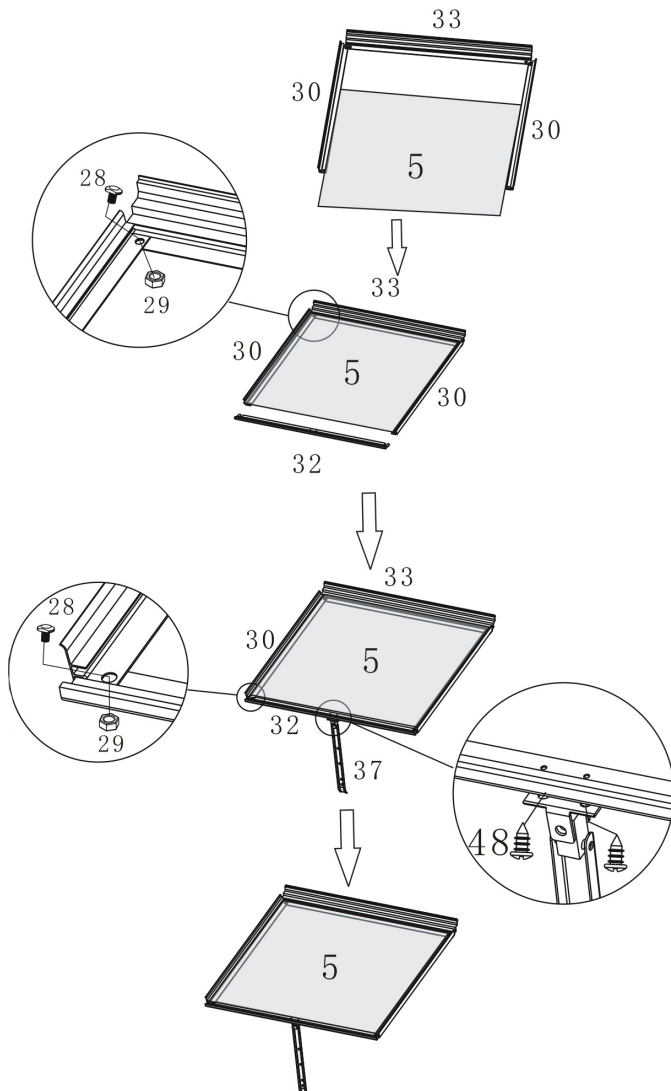

USER GUIDE

ASSEMBLY INSTRUCTIONS

 INSTRUCTIONS DE MONTAGE

 MONTAGEANLEITUNG

 INSTRUCCIONES DE MONTAJE

 ISTRUZIONI DI MONTAGGIO

 MONTAGEHANDLEIDING

2

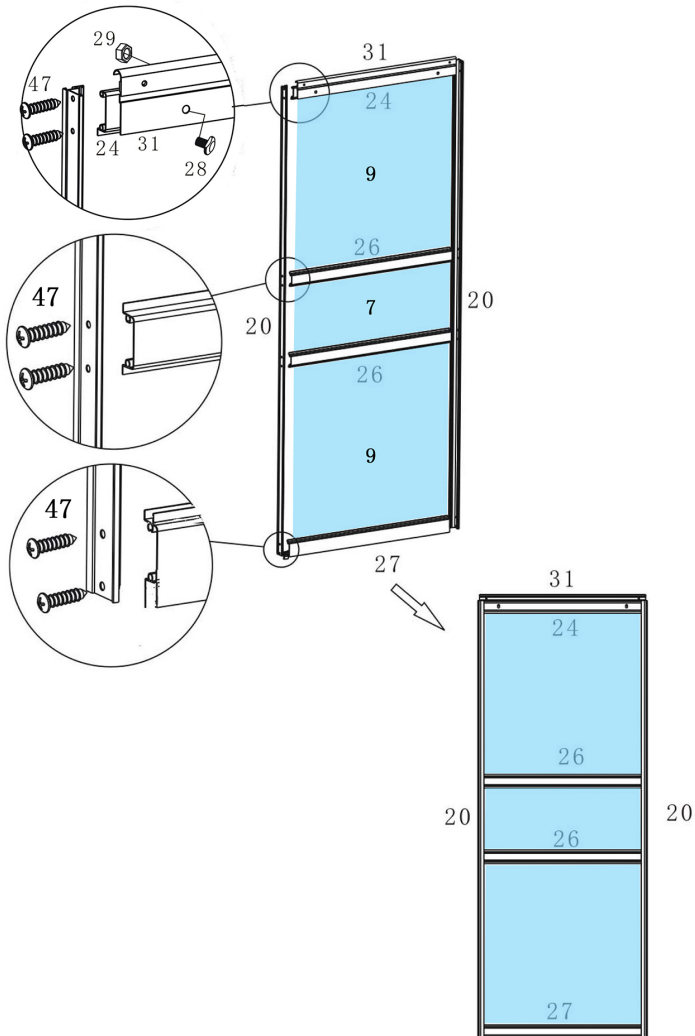

USER GUIDE

ASSEMBLY INSTRUCTIONS

 INSTRUCTIONS DE MONTAGE

 MONTAGEANLEITUNG

 INSTRUCCIONES DE MONTAJE

 ISTRUZIONI DI MONTAGGIO

 MONTAGEHANDLEIDUNG

3

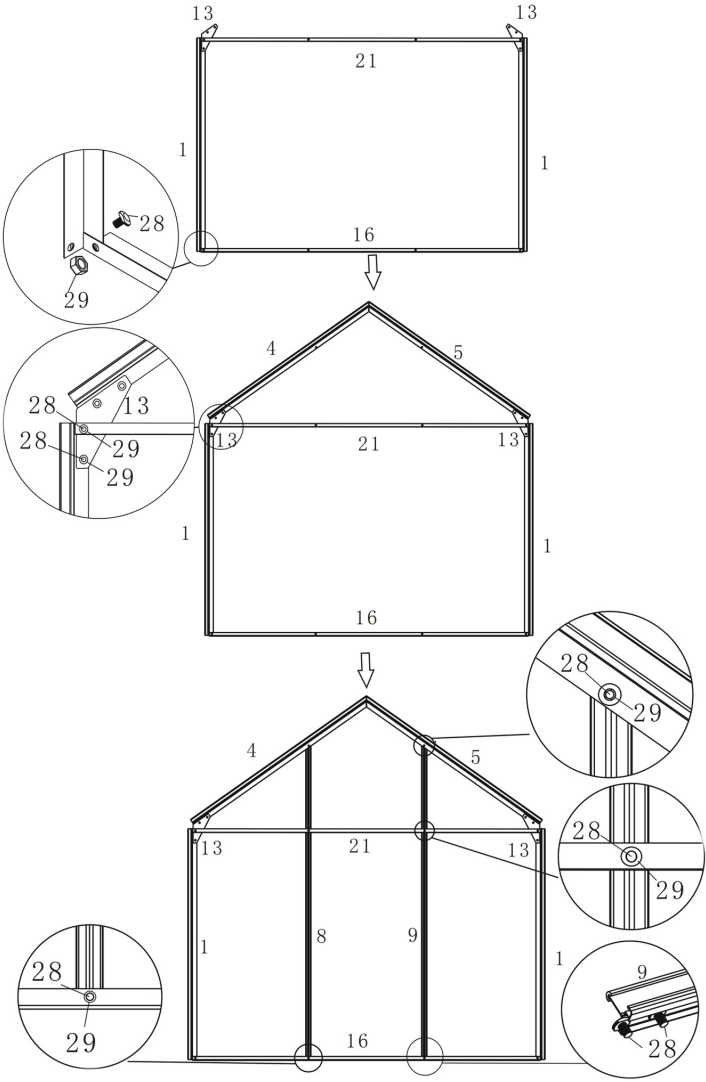

USER GUIDE

ASSEMBLY INSTRUCTIONS

 INSTRUCTIONS DE MONTAGE

 MONTAGEANLEITUNG

 INSTRUCCIONES DE MONTAJE

 ISTRUZIONI DI MONTAGGIO

 MONTAGEHANDLEIDING

4-1

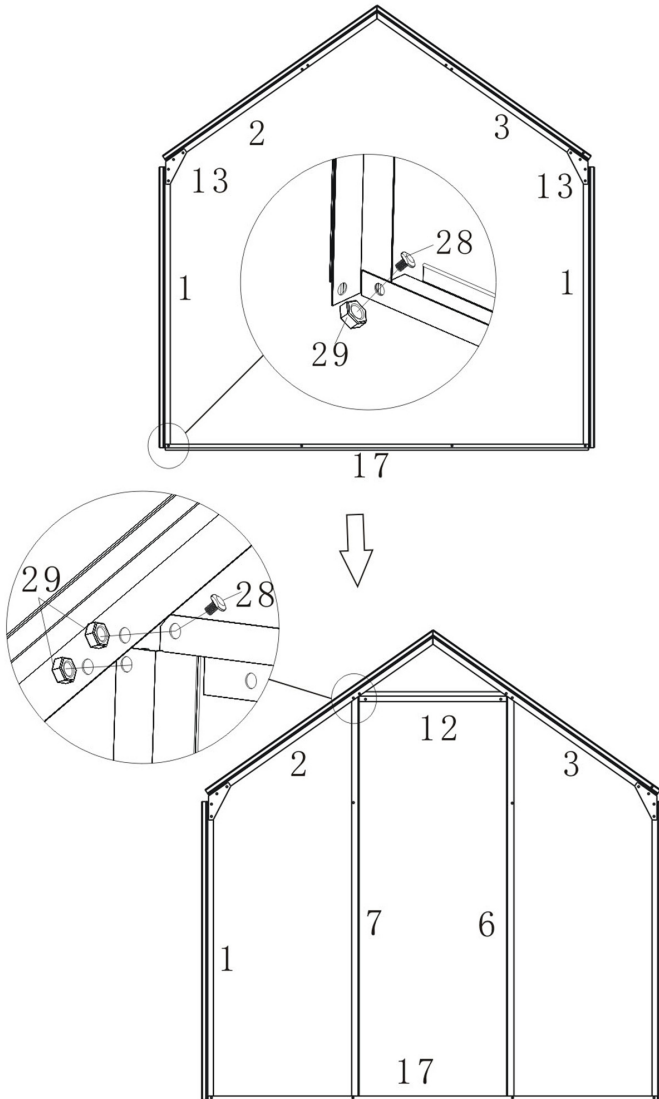

USER GUIDE

ASSEMBLY INSTRUCTIONS

 INSTRUCTIONS DE MONTAGE

 MONTAGEANLEITUNG

 INSTRUCCIONES DE MONTAJE

 ISTRUZIONI DI MONTAGGIO

 MONTAGEHANDLEIDING

4-2

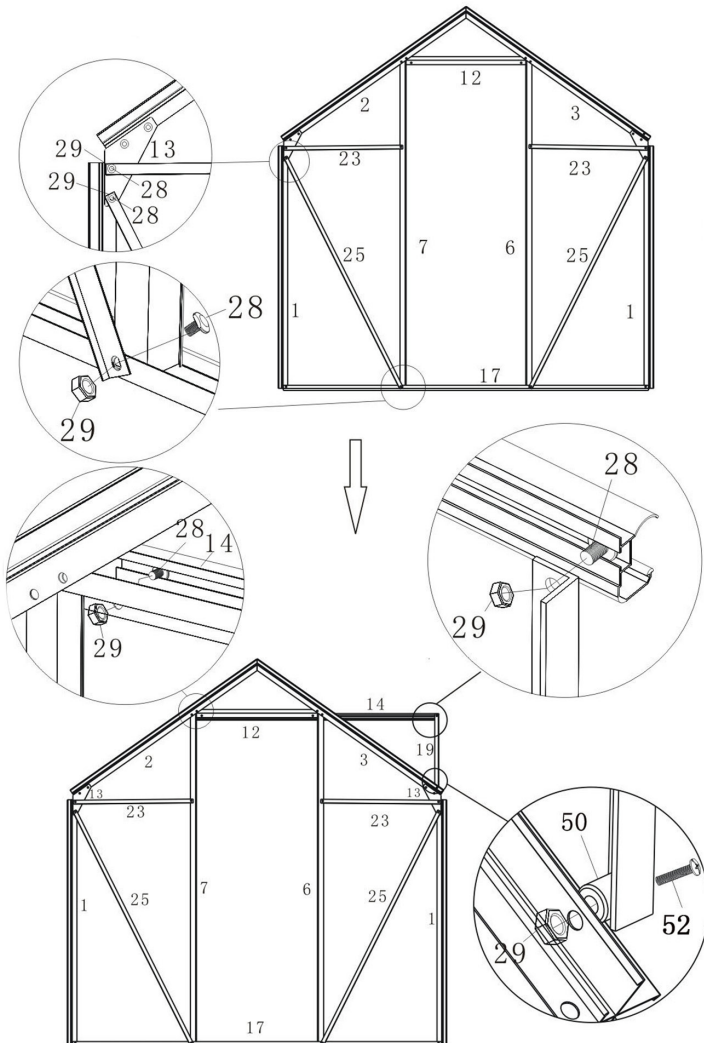

USER GUIDE

ASSEMBLY INSTRUCTIONS

 INSTRUCTIONS DE MONTAGE

 MONTAGEANLEITUNG

 INSTRUCCIONES DE MONTAJE

 ISTRUZIONI DI MONTAGGIO

 MONTAGEHANDLEIDING

5

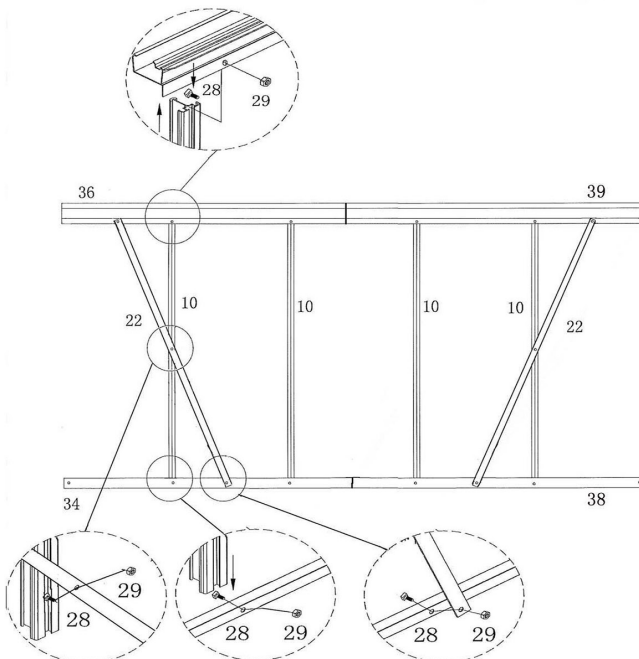
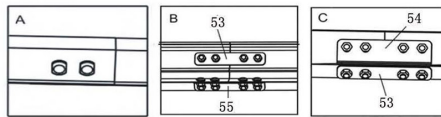
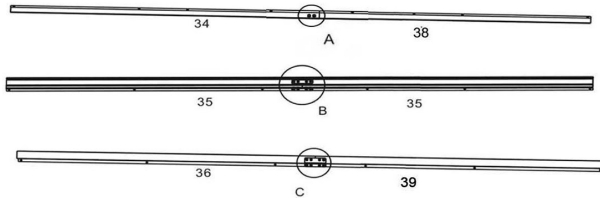

USER GUIDE

ASSEMBLY INSTRUCTIONS

 INSTRUCTIONS DE MONTAGE

 MONTAGEANLEITUNG

 INSTRUCCIONES DE MONTAJE

 ISTRUZIONI DI MONTAGGIO

 MONTAGEHANDLEIDUNG

6-1

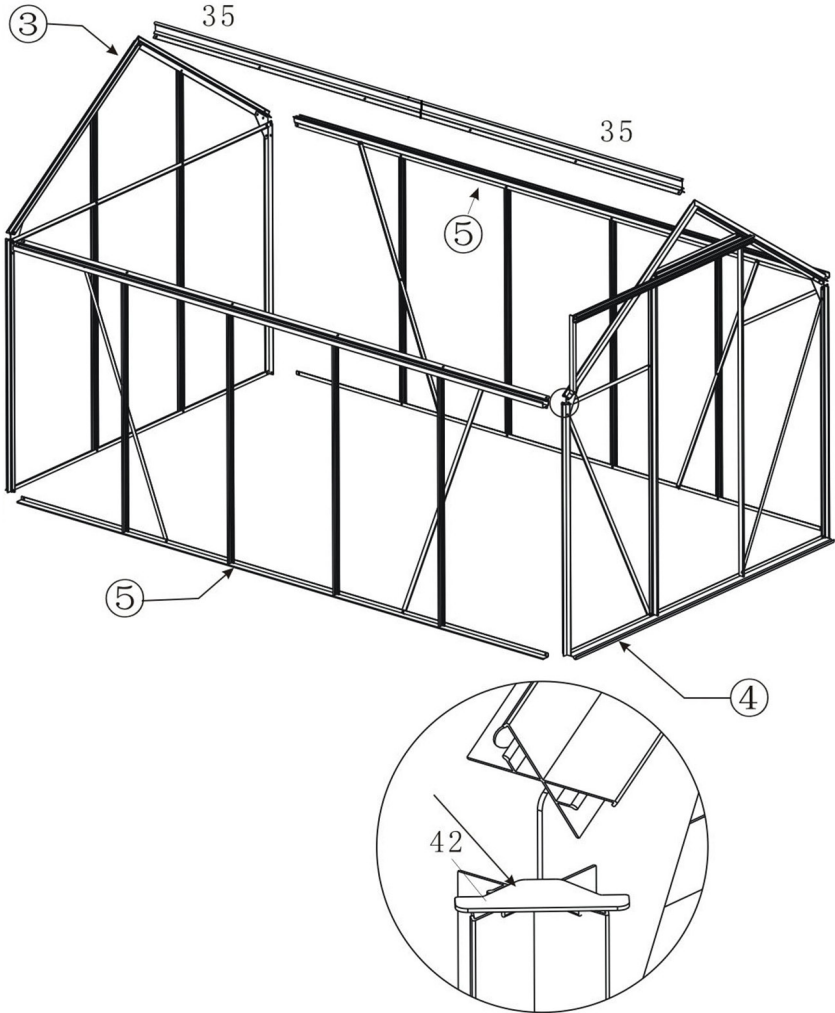

USER GUIDE

ASSEMBLY INSTRUCTIONS

 INSTRUCTIONS DE MONTAGE

 MONTAGEANLEITUNG

 INSTRUCCIONES DE MONTAJE

 ISTRUZIONI DI MONTAGGIO

 MONTAGEHANDLEIDING

6-2

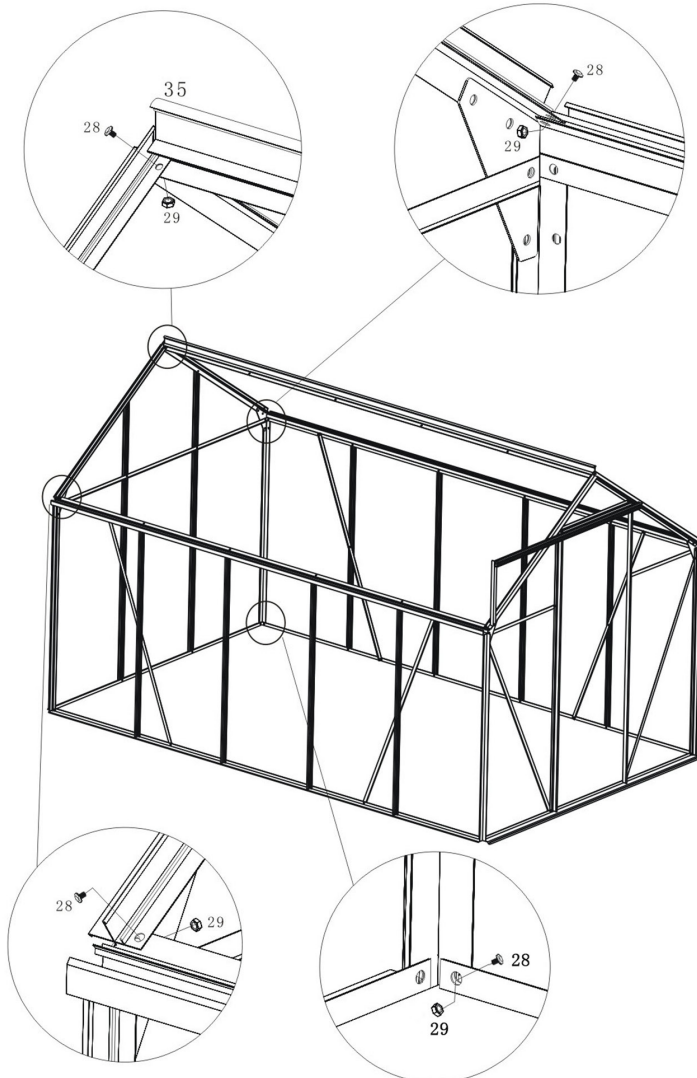

USER GUIDE

ASSEMBLY INSTRUCTIONS

 INSTRUCTIONS DE MONTAGE

 MONTAGEANLEITUNG

 INSTRUCCIONES DE MONTAJE

 ISTRUZIONI DI MONTAGGIO

 MONTAGEHANDLEIDING

7

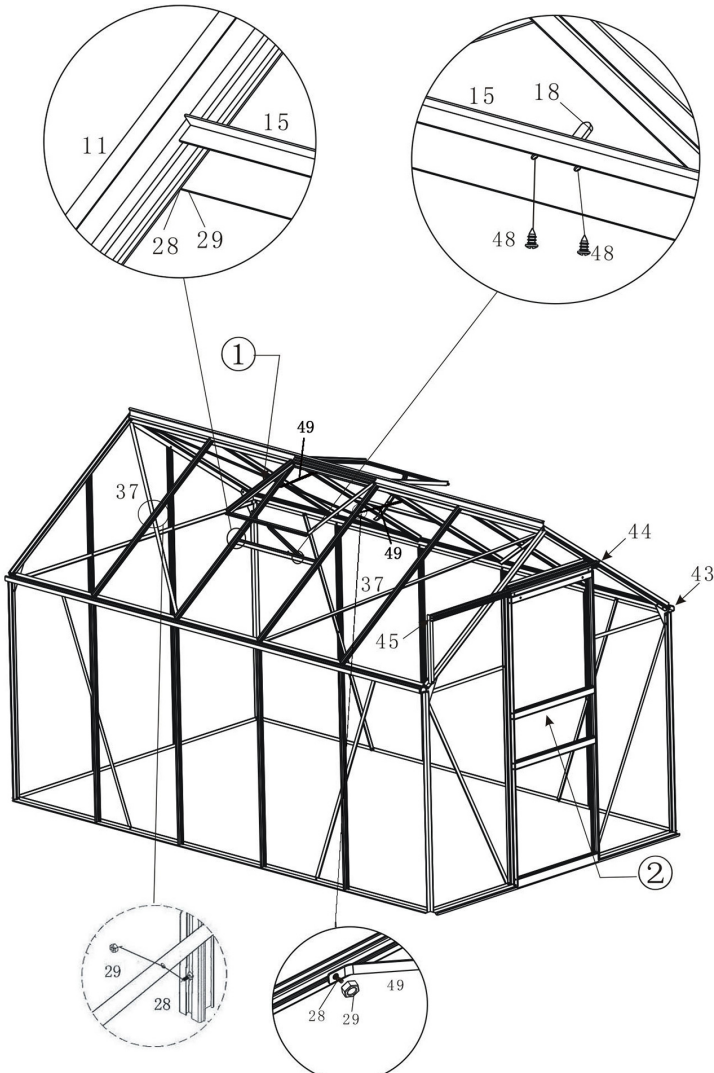

USER GUIDE

ASSEMBLY INSTRUCTIONS

 INSTRUCTIONS DE MONTAGE

 MONTAGEANLEITUNG

 INSTRUCCIONES DE MONTAJE

 ISTRUZIONI DI MONTAGGIO

 MONTAGEHANDLEIDING

8

1	605 x 1210	15 x
2	605 x 1130	8 x
3	605 x 450	2 x
4	605 x 590	2 x
5	600 x 549	2 x
6	605 x 662	1 x
7	610 x 224	1 x
8	615 x 232	1 x
9	610 x 602	2 x
10	605 x 450	2 x

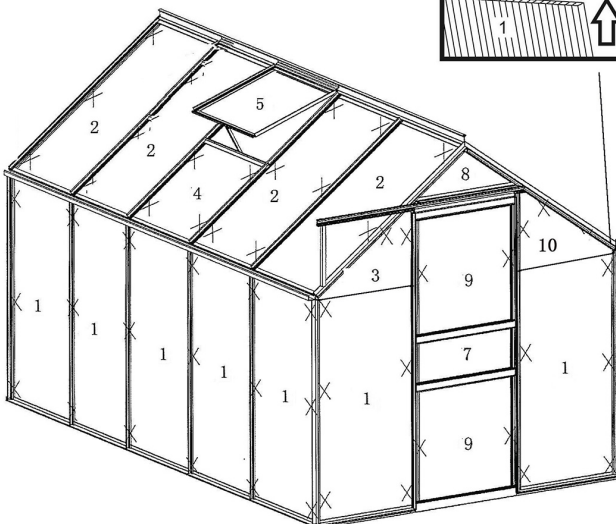
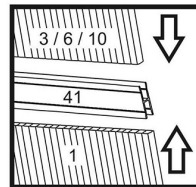
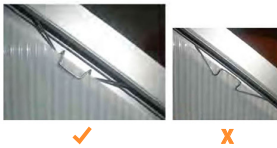
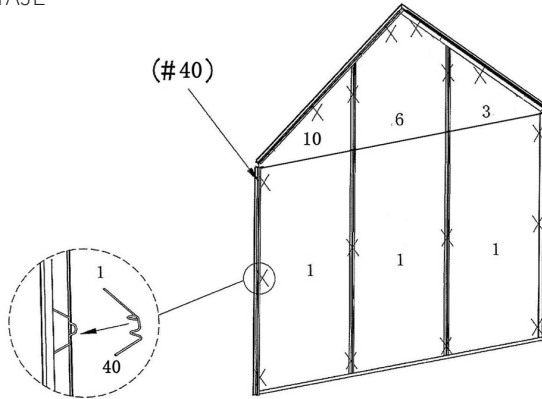

USER GUIDE

BASE

(The base is only included if you have ordered a model with a base included).

 (La base n'est incluse que si vous avez commandé un modèle avec une base incluse).

 (Der Sockel ist nur enthalten, wenn Sie ein Modell mit einem Sockel bestellt haben).

 (La base sólo se incluye si ha pedido un modelo con base incluida).

 (La base arriva solamente se viene ordinato un modello con base inclusa).

 (De basis is alleen inbegrepen als u een model met een basis heeft besteld).

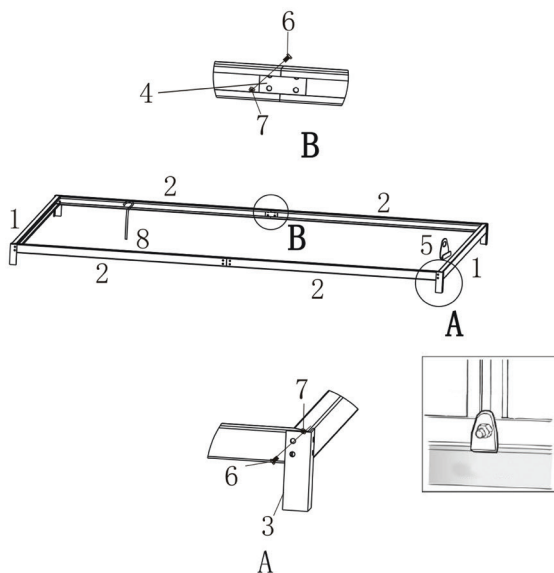
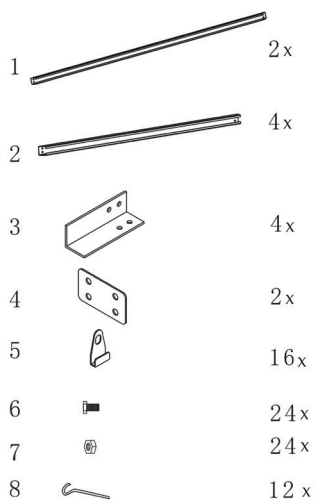

Monster Group (UK) is one of the UK's fastest growing online retailers. We supply a diverse range of products which offer exceptional value for money. We strive to provide the best possible customer experience with free UK delivery across all our products and a Monster Guarantee for 100% satisfaction.

For information regarding this device or other products from our Monster divisions please contact Sales.

SALES

TEL: 01347 878 888
EMAIL: hello@monstershop.co.uk

For queries about this device, warranty, returns or reporting faults please contact Support.

SUPPORT

TEL: 01347 878 887
EMAIL: help@monstershop.co.uk

Pour plus d'informations concernant cet appareil ou d'autres produits de nos divisions de Monster veuillez utiliser les détails suivants ci-dessous.

DÉPARTEMENT COMMERCIAL

TEL: 01347 878 888
EMAIL: hello@monstershop.co.uk

Pour les interrogations concernant cet appareil, la garantie, les retours ou les défauts de déclaration veuillez utiliser les détails suivants ci-dessous.

DÉPARTEMENT DE SOUTIEN

TEL: 01347 878 887
EMAIL: help@monstershop.co.uk

Para información sobre este dispositivo u otros productos de nuestras divisiones de Monster por favor use los siguientes detalles.

DEPARTAMENTO DE VENTAS

TEL: 01347 878 888
EMAIL: hello@monstershop.co.uk

Para consultas sobre este dispositivo, la garantía, devoluciones o denuncias de fallos por favor use los siguientes detalles.

DEPARTAMENTO DE SOPORTE

TEL: 01347 878 887
EMAIL: help@monstershop.co.uk

Für Informationen bezüglich dieses Geräts oder anderer produkte aus unserer Monster-Abteilung, benutzen sie die folgenden unten aufgeführten angaben.

VERKAUFABTEILUNG

TEL: 01347 878 888
EMAIL: hello@monstershop.co.uk

Für fragen über dieses gerät, die garantie, rückgaben oder bei störungen, benutzen sie die folgenden unten aufgeführten angaben.

SUPPORT-ABTEILUNG

TEL: 01347 878 887
EMAIL: help@monstershop.co.uk

Per informazioni riguardanti questo dispositivo o altri prodotti dalle categorie Monster utilizzare i dettagli sotto riportati.

DIPARTIMENTO VENDITE

TEL: 01347 878 888
EMAIL: hello@monstershop.co.uk

Per domande riguardo dispositivo, garanzia, reso o per riferire di guasti, utilizzare i dettagli sotto riportati.

DIPARTIMENTO SUPPORTO

TEL: 01347 878 887
EMAIL: help@monstershop.co.uk

Monster House, Alan Farnaby Way,
Sheriff Hutton Industrial Estate,
Sheriff Hutton, York, YO60 6PG
www.monstershop.co.uk



 Try **Monster**. Buy **Monster**. Be **Monster**. 



