

Standing Desk 120/140/160cm

214716 / 214717 / 214718

INSTRUCTION MANUAL

www.monstershop.co.uk



SPECIFICATION

PRODUCT DESCRIPTION

The Electric Standing Desk offers a versatile and ergonomic solution for your workspace. Available in three sizes (120cm, 140cm, and 160cm), it features convenient cable management with two cable holes, a spacious long cable tray, and a handy bag hook for added organisation. With three memory height settings and a low noise level, this desk ensures a smooth and quiet transition between sitting and standing, enhancing both comfort and productivity.



























ITEM CONTENTS 120cm/140cm DESK

①		1	⑩		1	Ⓕ	M4 × 22	2
②		1	⑪		1	Ⓖ		4
③		2	⑫		2	Ⓗ	S6	1
④		1				Ⓘ	S4	1
⑤		1	Ⓐ	M6 × 30	8	Ⓙ	S3	1
⑥		2	Ⓑ	M6 × 16	12	Ⓚ	S2.5	1
⑦		1	Ⓒ	M6 × 12	4	Ⓛ	M5 × 40	2
⑧		1	Ⓓ	M6 × 16	2	Ⓜ	5 × 9 × 18	2
⑨		1	Ⓔ	M6 × 50	4	Ⓝ	M4 × 5	4

Monster Group UK Limited's liability will be limited to the commercial value of the product only.

SPECIFICATION

ITEM CONTENTS 160cm DESK

①		1	⑩		1	Ⓕ	M4×22 	2
②		1	⑪		1	Ⓖ		4
③		2	⑫		2	Ⓗ	S6 	1
④		1	⑬		1	Ⓘ	S4 	1
⑤		1	Ⓐ	M6×30 	8	Ⓙ	S3 	1
⑥		2	Ⓑ	M6×16 	12	Ⓚ	S2.5 	1
⑦		1	Ⓒ	M6×12 	4	Ⓛ	M5×40 	2
⑧		1	Ⓓ	M6×16 	2	Ⓜ	5×9×18 	2
⑨		1	Ⓔ	M6×50 	4	Ⓝ	M4×5 	4

PRODUCT SPECIFICS

DESKTOP SIZE:	120x60cm/140x60cm/160x60cm
WEIGHT CAPACITY:	80kg
TABLETOP THICKNESS:	25mm
ADJUSTABLE HEIGHT RANGE:	70-115cm
MATERIAL:	MDF & Steel
POWER:	110-230V
SPEED:	20mm/s
NOISE LEVEL:	<50dB
MEMORY SETTINGS:	3

SAFETY ADVICE

SAFE WORKING PRACTICE

Please read through the Safe Working Practice to ensure prevention of injury or damage to the product.

- Do not use this product for anything other than its intended purposes.
- Ensure you have read and fully understood the instruction manual and safety advice before using this product.
- Assemble the desk according to the provided technical specifications. Re-tighten all screws periodically after initial assembly and continue to do so regularly to ensure long-term stability and safety.
- Only use the desk indoors, and keep it away from direct sunlight or environments with high temperatures, as these conditions may damage the materials and electrical components.
- Do not use the desk in environments with corrosive gases or excessive dust, and keep all electrical components (including the power supply and controller) away from any liquids to avoid electrical hazards or malfunction.
- Non-professionals must not disassemble or modify any part of the desk, especially the electrical components, to prevent the risk of electric shock or damage to the product.
- Keep children and pets away from the desk, its electrical controls, and moving parts at all times to prevent injury or electric shock.
- Do not stand, sit, or place excessive force on the desk frame, as it is not designed to support body weight.
- Ensure the total weight of objects placed on the desk does not exceed the specified weight capacity of 80kg to maintain stability and proper functionality.
- Avoid placing objects taller than 500mm underneath the desk, as they may obstruct the desk's movement and cause damage or malfunction during height adjustments.
- Always unplug the desk from the electrical outlet during maintenance or if it will not be used for extended periods.

- Always maintain a clear and hazard-free workspace around the desk during assembly and use. Do not leave tools or packing materials in the workspace, and be cautious with plastic packaging materials, which can pose a risk of suffocation or strangulation if children access them.
- The desk should not be operated continuously for more than 2 minutes at a time. After each 2-minute operation period, allow an 18-minute break to avoid overheating or excessive strain on the motor.
- Regularly inspect the desk's power cable and electrical components for signs of wear or damage. If any defects are found, stop using the desk immediately and contact a qualified technician for repairs.
- The desk operates on a power supply of 110-240V and 50/60Hz. Ensure your power source is compatible with these specifications before connecting the desk to the electrical outlet.
- When adjusting the desk height, ensure that no obstacles are in the path of the moving components to prevent damage or personal injury. Always be aware of the surroundings to avoid trapping fingers, cables, or other objects.
- Keep the noise level below 50dB while operating the desk to avoid disturbance or potential hearing risks in quiet environments.
- The desk has three memory settings for adjusting the height. Use these settings appropriately to avoid repetitive manual adjustments and ensure optimal ergonomic positioning.
- If you plan to move or transport the desk, retain the original packaging to ensure safe transportation and protect the desk from damage.
- The desk is equipped with a motor that moves the surface at a speed of 20mm/s. Do not attempt to force the desk to move faster or slower manually, as this may damage the motor or cause injury.
- Avoid plugging in or unplugging the desk with wet hands to reduce the risk of electric shock.
- Ensure the desk is placed on a flat, stable surface to prevent tipping or instability. Regularly check the surface to ensure the desk remains level and secure.
- Turn off and unplug the desk at the end of each day or when it will not be in use for extended periods to reduce energy consumption, prevent electrical hazards, and prolong the lifespan of the desk's motor and electrical components.

USER GUIDE

OPERATING INSTRUCTIONS

Before using the desk for the first time, please follow these instructions to reset the desk (RST mode). Resetting the desk can help with certain error codes; please check the error code table.

- To reset the desk, press and hold the “DOWN” key until the motor stops, then release the key. Press the “DOWN” key again, and hold it for at least 5 seconds to enter the reset mode. Keep pressing the “DOWN” key until the buzzer beeps, which indicates that the reset was successful. Please do not release the key early, as this will interrupt the reset of the desk.

UP AND DOWN KEYS

When the “UP” key is pressed and held, the desk rises until it reaches the highest point possible. When the “DOWN” key is pressed and held, the desk lowers until it reaches the lowest point possible. When the “UP” or “DOWN” key is pressed only for a short time, the desk rises/lowers according to how long the key is pressed.

SETTING MEMORY HEIGHT

The system allows for 3 different memory heights to be stored at the same time. To have the system memorise a specific height, please start by raising/lowering the desk to the desired position. Then press the “S” key. The Digital Control Panel will show “S-”, and “-” will flash. Now you can press any key number 1/2/3 to memorise the current desk position. Whenever you want the desk to reach a memorised height, you only need to press the corresponding number key. To interrupt this process, press any key.

SET MAX AND MIN HEIGHT LIMITS

Bring the desk to the height you would like to set as either the highest point (MAX) or the lowest point (MIN). Then press and hold the “UP” and “DOWN” keys at the same time for 5 seconds, until you hear a buzzer sound, indicating that the chosen height has been saved successfully as your MAX/MIN.

To delete the memorised height limits, you can either reset the system entirely or let the desk rise/lower to its height limit (MAX/MIN) and press and hold the “UP” and “DOWN” keys at the same time for 5 seconds, until the buzzer sound indicates that the height limit has been deleted successfully.

FACTORY RESET

When the system needs to be restored to factory settings, press and hold “UP” and “DOWN” at the same time for 10 seconds to hear a long buzzer prompt. Now, the parameters are restored to factory settings, and the system is forced to complete the reset.

USER GUIDE

OPERATING INSTRUCTIONS



KEY	ACTION
S	Settings
^	(5) Up
v	(6) Down
1	Memory slot 1
2	Memory slot 2
3	Memory slot 3

LOCK AND UNLOCK

Lock: Press and hold “S” and “UP” at the same time for 5 seconds; when the Digital Control Panel shows “Loc”, it means that the system has been locked, so the desk cannot be raised or lowered.

Unlock: Press and hold “S” and “DOWN” at the same time for 5 seconds; when the Digital Control Panel changes from “Loc” to the normal display, it means the system has been unlocked.

SET TIMER

Press the “1” and “3” buttons on the digital control panel to display “x.xh” on the Digital Control Panel. You can then use the “UP” or “DOWN” buttons to adjust the time in 0.5-hour increments. The system will automatically exit this setting mode after 2 seconds. Once the digital display turns off, a flashing decimal point will indicate that a timer is running. When the set time is reached, the buzzer will sound five times, and the Digital Control Panel will automatically wake up.

AUTOMATIC TESTING

The Digital Control Panel allows the system to run an automatic test cycle, where it operates for 2 minutes and then stops for 18 minutes. This test cycle moves between the storage positions S1 and S2. To enable automatic operation in this mode, you need to set the storage position control to active by setting S-6 to 1. Once activated, the system will cycle back and forth between S1 and S2 for 2 minutes, pause for 18 minutes, and repeat this process indefinitely.

To enter this mode, press and hold the “UP,” “DOWN,” and “S” buttons simultaneously for 2 seconds. When all the decimal points on the display light up, it indicates the system is in automatic test mode. To exit, press and hold the “UP,” “DOWN,” and “S” buttons again for 2 seconds.

USER GUIDE

OPERATING INSTRUCTIONS

SETTING INTERNAL PARAMETERS

To access the settings menu, press and hold the “S” button on Digital Control Panel for 5 seconds. When “S-x” appears on the display and the “x” begins to flash, it indicates the parameter group number. Press “S” again to enter the selected parameter group and adjust the relevant settings. Use the “UP” or “DOWN” buttons to switch between parameter groups. After adjusting the settings, press “S” to return to the normal operating interface. The available parameter groups are:

- a. S-1: Determines the unit of measurement: 0 for metric (cm) and 1 for imperial (inches).
- b. S-2: Adjusts the sensitivity level for obstacle detection when moving downward. A setting of 0 turns off the sensor, while 1 is the least sensitive and 8 is the most sensitive.
- c. S-3: Sets the sensitivity level for obstacle detection when moving upward. A value of 0 disables the sensor, while 1 is the least sensitive and 8 is the most sensitive.
- d. S-4: Configures sensitivity for detecting obstructions while moving downward, with the same scale as above (0 for off, 1-8 for sensitivity).
- e. S-5: Sets the adjustment increments, measured in centimetres.
- f. S-6: Controls the desk’s movement behaviour when using the preset position feature. A value of 0 requires holding the preset button to move the desk, and the desk stops when the button is released. A value of 1 makes the desk automatically move to the preset position when the button is pressed, and any button can stop it.
- g. S-7: Adjusts the duty cycle for desk operation. A setting of 0 disables the 2-minute-on, 18-minute-off cycle, relying only on temperature monitoring to protect the control box. A setting of 1 enables the 2-minute/18-minute duty cycle.
- h. S-8: Configures the sensitivity to detect desk tilt, helping prevent uneven leg movement caused by issues like a damaged screw rod. A value of 0 turns off tilt detection, while values from 1 to 8 correspond to an inclination angle range of 0.5° to 4°.

USER GUIDE

ERROR CODE TABLE

ERRORS	MEANING	RESOLUTION
E1	mains voltage exceeds 45V	check main supply power
E2	the height deviation between the screw rods exceeds 1cm	reset the system again
E4	system or Digital Control Panel panel error	check Digital Control Panel cable
E5	stops when encountering resistance	release the key and restart
E6	the main power supply does not work/ the voltage is lower than 20V	replace the main power supply, or check the main power supply cable
E7	protection when main power supply is running/ the voltage is lower than 20V	power on again
E8	desk tilts when running	reset the system again
HOT	power supply temperature is too high/ desk runs for longer than 2 minutes in 18 minutes	wait for power supply temperature to cool down/ let the system cool down for 18 minutes
E11	motor 1 not connected	check the connection cable
E12	motor 1 current sampling channel error	replace the control board
E13	motor 1 phase loss/ phase cable is not connected	check the motor phase cable connection for any issues
E14	motor 1 hall error/ hall cable is not connected	check the hall signal/ replace connection cable
E15	motor 1 internal shortcircuit	replace the motor
E16	motor 1 stall	reset the system again
E17	the running direction of motor 1 is wrong	replace the motor cable/ hall cable
E18	motor 1 load is too large/ overload	reduce the load
E21	motor 2 not connected	check the connection cable

USER GUIDE

ERROR CODE TABLE









E22	motor 2 current sampling channel error	replace the control board
E23	motor 2 phase loss/ phase cable is not connected	check the motor phase cable connection for any issues
E24	motor 2 hall error/ hall cable is not connected	check hall signal/ replace the connection cable
E25	motor 2 internal shortcircuit	replace the motor
E26	motor 2 stall	reset the system again
E27	the running direction of motor 2 is wrong	replace the motor cable/ hall cable
E28	motor 2 load is too large/ overload	reduce the load
E40	the Digital Control Panel keeps disconnecting	check the connection cable
E41	the serial signal is wrong	check the connection cable/ replace the Digital Control Panel
E42	memory error	replace the Digital Control Panel
E43	sensor error (enabling desk to stop when encountering resistance)	replace the Digital Control Panel

USER GUIDE

ASSEMBLY INSTRUCTIONS

120cm/140cm DESK

Step 1

①	S4		1	Ⓛ	M5×40		2
①			1	Ⓜ	5×9×18		2
②			1	⑨			1
③			2				
Ⓐ	M6×30		8				

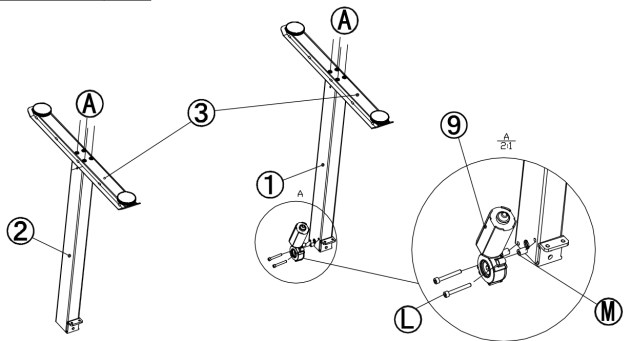

Step 2

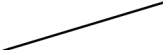
Ⓗ	S6		1
⑤			1

NOTE:

When inserting (5), gently rotate (H) and ensure you insert it fully.

2 people may be needed for this step, to prevent the table legs from toppling mid-assembly.

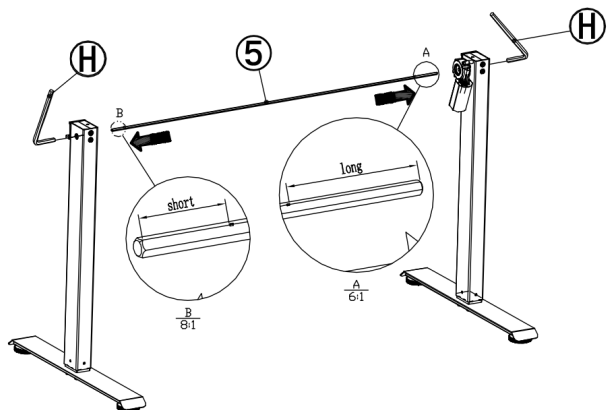





USER GUIDE

ASSEMBLY INSTRUCTIONS



120cm/140cm DESK

Step 3

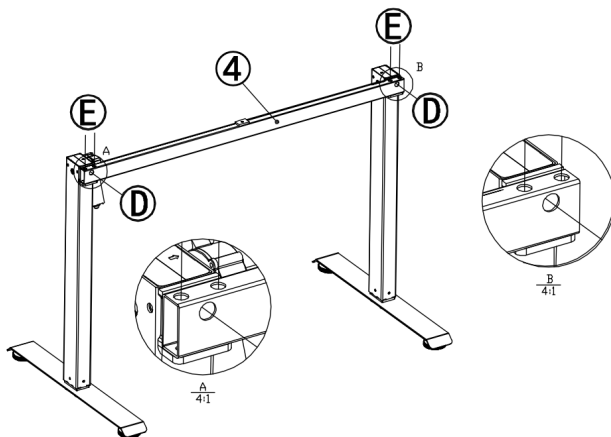
①	S4		1
④	M6×50		4
④	M6×16		2
④			1





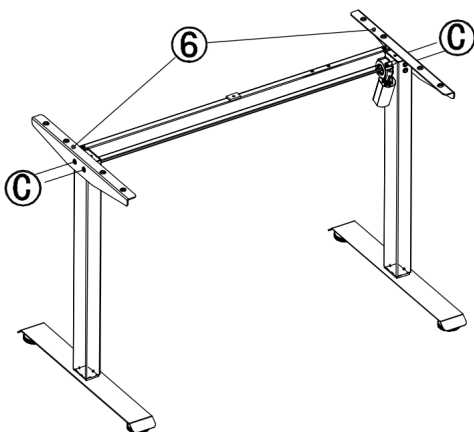

Step 4

①	S4		1
⑥			2
③	M6×12		4



Step 5

①	S2.5		1
①	M4×5		4
①			1
①			2

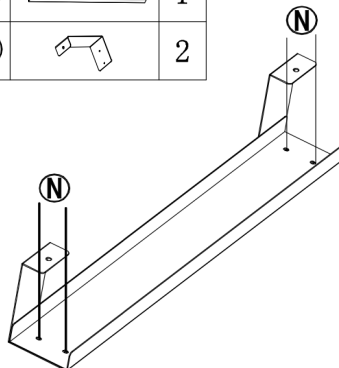









USER GUIDE

ASSEMBLY INSTRUCTIONS



120cm/140cm DESK

Step 6

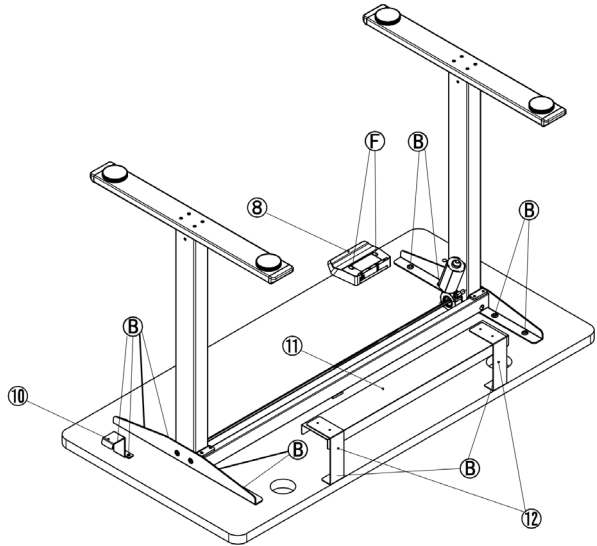
①	S4		1
②	S3		1
③	M4×22		2
④	M6×16		12
⑤			1
⑩			1
⑪			1
⑫			2



Step 7

⑥		4
⑧		1
⑦		1

Connection diagram

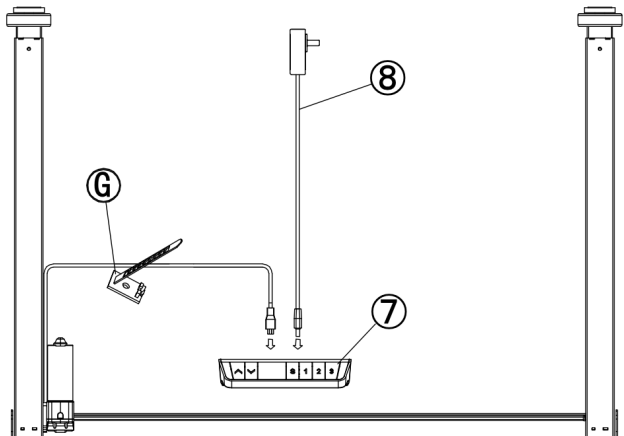

USER GUIDE

ASSEMBLY INSTRUCTIONS

160cm DESK

Step 1

①	S4		1	Ⓛ	M5×40		2
①			1	Ⓜ	5×9×18		2
②			1	⑬			1
③			2				
Ⓐ	M6×30		8				

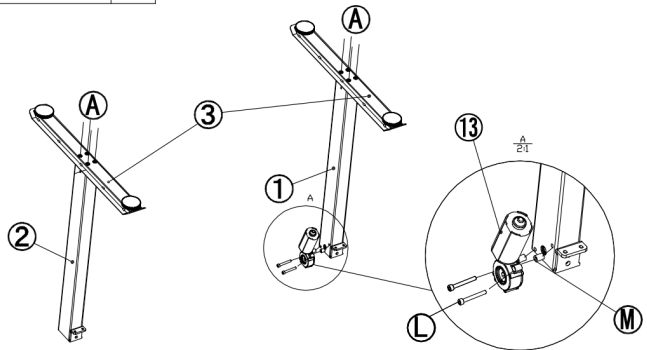

Step 2

①	S4		1
Ⓔ	M6×50		4
Ⓓ	M6×16		2
④			1

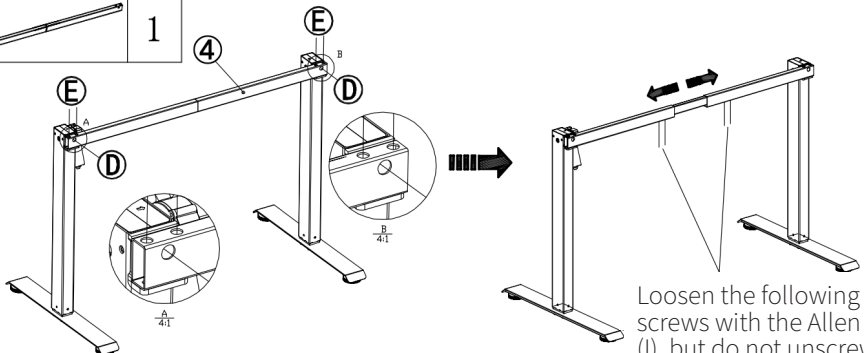



Loosen the following 4 screws with the Allen Key (1), but do not unscrew them fully, as it will make it difficult to install.

USER GUIDE

ASSEMBLY INSTRUCTIONS

Step 3

160cm DESK

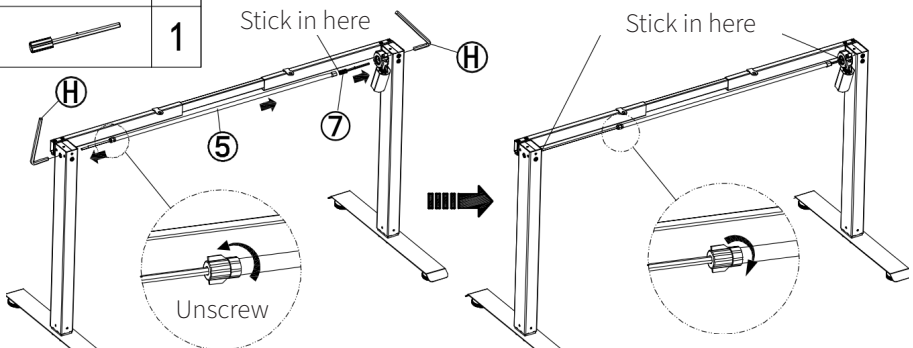

(H)	S6		1
(5)			1
(7)			1



Note: When it is difficult to insert (5), gently turn (H) back and forth to insert it with ease.



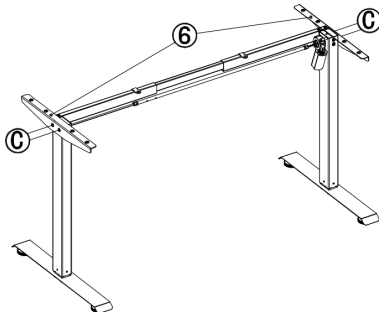

Insert both sides to the end and tighten them.

Step 4

(1)	S4		1
(6)			2
(C)	M6×12		4



Step 5

(K)	S2.5		1
(N)	M4×5		4
(11)			1
(12)			2

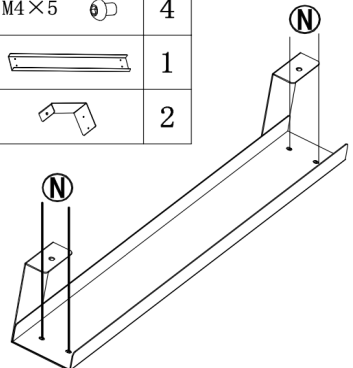









USER GUIDE

ASSEMBLY INSTRUCTIONS



160cm DESK

Step 6

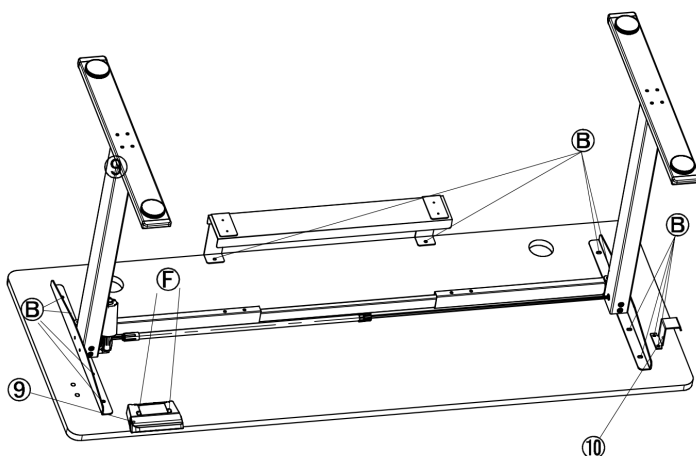
①	S4		1
②	S3		1
③	M4×22		2
④	M6×16		12
⑤			1
⑥			1
⑦			1
⑧			2



Step 7

①		4
②		1
③		1

Connection diagram

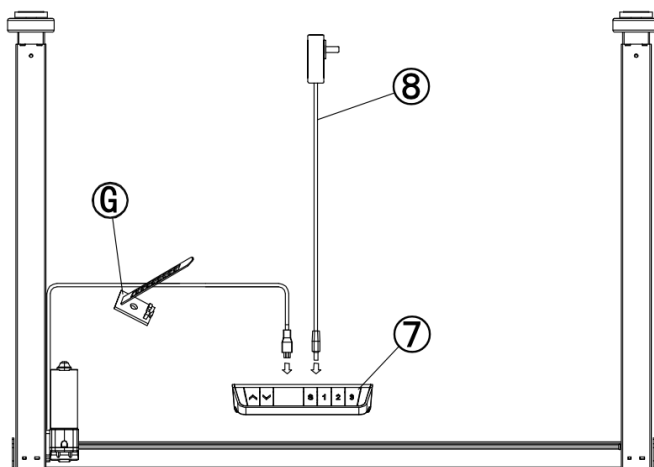

TROUBLESHOOTING

RESOLUTION GUIDE

WHAT DO I DO IF THERE ARE MISSING PARTS FROM MY ORDER?

If there appears to be any part missing from your order, contact our friendly and helpful Customer Support Team within 7 days of receipt.

**FOR ALL OTHER ISSUES, PLEASE CONTACT OUR
CUSTOMER SUPPORT TEAM.**